

Événement de 3 semaines | du 7 au 27 mai 2026
3-Week Event | May 7 - 27, 2026



En pleine nature

Printemps/Spring 2026

Votre guide
pour les
aventures
de plein air

Your Guide to
Outdoor Adventures



NOTRE MAGASIN^{MC}
CANADA'S STORE™



JOUR DE PRIME

Récompenses Triangle

Triangle Rewards

BONUS DAY

JEUDI 7 MAI 2026

Dépensez 150 \$+* sur
presque tous les articles
et obtenez

THURSDAY, MAY 7, 2026

Spend \$150+*
on almost everything and collect

20x SOIT
THAT'S
8% 

**l'Argent CT^{MD}* en prime
Bonus CT Money[®]***

30x SOIT
THAT'S
12% 

**l'Argent CT^{MD}* au total
Total CT Money[®]***

en magasin et en ligne.

*Achats avant taxes. Des
conditions s'appliquent.

in-store and online.

*Pre-tax purchase. Conditions apply.

*Le min. de 150 \$ de dépenses s'applique
au montant avant taxes sur l'offre pour
une transaction sur des articles qui
donnent droit à l'Argent CT. Détails à
l'intérieur de la couverture arrière.

*Min. \$150 spend is on the pre-tax amount
on the same tender and for a single
transaction on items that earn CT Money.
See inside back page for details.

En pleine nature

The Outsider

Rien de plus simple que de conquérir les grands espaces quand on a tout le matériel nécessaire pour partir à l'aventure et en profiter.

Making the most of the Great Outdoors is a breeze when you've got the gear on your checklist to get up, get out & have fun.



Dégustez des repas lyophilisés haut de gamme aux saveurs intenses, relevées et gourmandes./Enjoy premium freeze-dried meals made with bold, vibrant and comforting flavours.



N° 1 de la détection des métaux, découvrez la technologie révolutionnaire de Minelab qui redéfinit la performance et la fiabilité dans les environnements les plus hostiles au monde./#1 in metal detection, experience ground-breaking technology with Minelab – redefining performance and reliability in the world's most challenging environments.



Tommy Bahama

Bienvenue dans ce qui se fait de mieux pour se détendre, faire une pause et profiter de l'instant présent./Welcome to the very best in lifestyle essentials so you can relax, exhale and enjoy the moment.

NOUVEAUTÉ
NEW

Prenez un moment pour découvrir quelques-uns des grands noms que nous avons ajoutés à notre gamme de marques de confiance pour le plein air.

Take a moment and get to know some of the great names we've added to our lineup of trusted outdoor brands.

CONNELLY

Dédié à la recherche et à l'innovation, Connelly est en tête depuis plus de 50 ans./Dedicated to research and innovation, Connelly has been creating serious waves for over 50 years.



SUZUKI

Pour vivre une aventure nautique inoubliable, trouvez le moteur hors-bord qui vous convient et vivez la vie selon Suzuki!/For your ultimate boating adventure, find your perfect outboard motor and experience the Suzuki Way Of Life!



Hydro Flask

Un équipement à toute épreuve qui vous permettra d'étancher votre soif de l'aventure et de profiter au maximum de la nature./Help quench your thirst for nature with 'go-anywhere' gear that lets you make the most of every minute.



Quand il s'agit de s'habiller pour le climat canadien qui change constamment, Huntshield s'impose./When it comes to being dressed for ever-changing Canadian weather, look no further than Huntshield.



Fondée en 1877, Helly Hansen conçoit de l'équipement professionnel pour aider les gens à profiter de la vie./Founded in 1877, Helly Hansen develops professional-grade gear to help people stay and feel alive.



Woods équipe les explorateurs canadiens depuis 1885 et, grâce à ses créations fiables et durables, contribue à inspirer les aventuriers./Outfitting Canadian explorers since 1885, Woods helps inspire adventurers with reliable, durable designs.



Pensez-y

Contribue à emporter le confort avec vous dans votre camping grâce à ces incontournables.

Check it off

Help pack comfort into your camping trip with these musts.



RABAIS/SAVE 90 \$ GLACIÈRE RIGIDE POUR LE BATEAU, 120 PTE Conçue pour les longues journées et les conditions difficiles, grâce au revêtement UVGuard qui protège du soleil. / **MARINE HARD COOLER, 120-QT** Built for long days and harsh conditions with our UVGuard coating for protection from the sun. 85-4287-2. Cour./Reg 249,99...**SOLDE/SALE 159,99**



ABRI PARE-SOLEIL FACILE À INSTALLER OUTBOUND, 10 X 10 PI/OUTBOUND 10 X 10' EASY-UP CANOPY SHELTER 76-5464-6...**129,99**
COUVERTURE DE CAMPING OU BÂTONS DE RANDONNÉE WOODS/ WOODS CAMP BLANKET OR TREKKING POLES 76-6877X...**29,99-79,99**

La Semaine Nationale de la Pêche au Canada
Canada's National Fishing Week

Du 27 juin au 5 juillet 2026 – ne manquez pas de profiter des joies de la pêche récréative et de passer du bon temps avec vos proches. Tous les détails se trouvent à www.catchfishing.com.

June 27 – July 5, 2026 be sure to get out and enjoy the thrill of recreational fishing and connect with friends and family. For more information visit www.catchfishing.com.



1. RABAIS/SAVE 75 \$ ENS. DE TABLE DE CAMPING POUR 4 PERSONNES/ **4-PERSON FOLDING CAMP TABLE SET** 76-6412-4. Cour./Reg 184,99...**SOLDE/SALE 109,99**

CERTAINS SACS DE COUCHAGE/SELECTED SLEEPING BAGS 76-5426X...**29,99-54,99**

2. RABAIS/SAVE 55 \$ TENTE DÔME À 2 PIÈCES POUR 8 PERSONNES/ **8-PERSON, 2-ROOM DOME TENT** 76-5454-0. Cour./Reg 184,99...**SOLDE/SALE 129,99**

TENTE DÔME POUR 6 PERSONNES OU FAUTEUIL DE CAMPING PLIANT/ 6-PERSON DOME TENT OR FOLDING CAMPING CHAIR 76-5445X...**19,99-99,99**

3. RABAIS/SAVE 30 % MATELAS PNEUMATIQUE DOUBLE ÉPAISSEUR, GRAND DEUX PLACES AVEC POMPE DE 120 V/QUEEN DOUBLE-HIGH AIR BED WITH 120V PUMP 76-6021-4. Cour./Reg 114,99...**SOLDE/SALE 79,99**

CERTAINS MATELAS PNEUMATIQUES/SELECTED AIR BEDS 76-6101X...**21,99-39,99**



4. FAUTEUIL DE CAMPING PLIANT ENTIÈREMENT REMBOURRÉ DE LUXE/ DELUXE FULLY PADDED FOLDING CAMPING CHAIR 76-6807-6. Cour./Reg 119,99...**SOLDE/SALE 89,99**

5. FAUTEUIL DE CAMPING SURDIMENSIONNÉ REMBOURRÉ DE MOUSSE/ FOAM-PADDED OVERSIZED CAMPING CHAIR 76-5547-0. Cour./Reg 79,99...**SOLDE/SALE 59,99**

CERTAINS HAMACS/SELECTED HAMMOCKS 76-3711X. Cour./Reg 39,99-54,99...**SOLDE/SALE 29,99-39,99**

ACHAT SPÉCIAL/SPECIAL BUY
CHARIOT PLIANT SEINA, CAPACITÉ DE 150 LB MAX/SEINA FOLDING WAGON UP TO 150-LB CAPACITY 299-9350-2...**74,99**

Jusqu'à épuisement des stocks./While quantities last.



**RABAIS
SAVE
25 %**



WOODS™

SAC À DOS CHILKOOT, 70 L/
CHILKOOT BACKPACK, 70L
76-6176-6...199,99

SAC À DOS CHILKOOT, 55 L/
CHILKOOT BACKPACK, 55L
76-6177-4...174,99



1. BÂTONS DE RANDONNÉE ANTICHOCS
À 3 SECTIONS/ANTI-SHOCK 3-STAGE
TREKKING POLES 76-6882-4...29,99

BÂTONS DE RANDONNÉE À BLOCAGE
RAPIDE, 3 SECTIONS/QUICK-LOCK
3-STAGE TREKKING POLES 76-6883-2...39,99

RABAIS/SAVE 25 % BÂTONS DE RANDONNÉE
WOODS/WOODS TREKKING POLES 76-6414-0.
Cour./Reg 72,99...SOLDE/SALE 53,99

2. SAC DE RANDONNÉE PORTAGE WOODS/
WOODS PORTAGE DRY PACK 76-3728-2...109,99
CERTAINS SACS À DOS ET SACS D'HYDRATATION
WOODS OU OUTBOUND/SELECTED WOODS OR
OUTBOUND BACKPACKS AND HYDRATION PACKS
76-3602X...9,99-199,99



WOODS™



RABAIS/SAVE 45 \$
ABRI DE DOUCHE ET D'INTIMITÉ SITKA/SITKA
PRIVACY AND SHOWER SHELTER 76-3740-0.
Cour./Reg 174,99...SOLDE/SALE 126,99

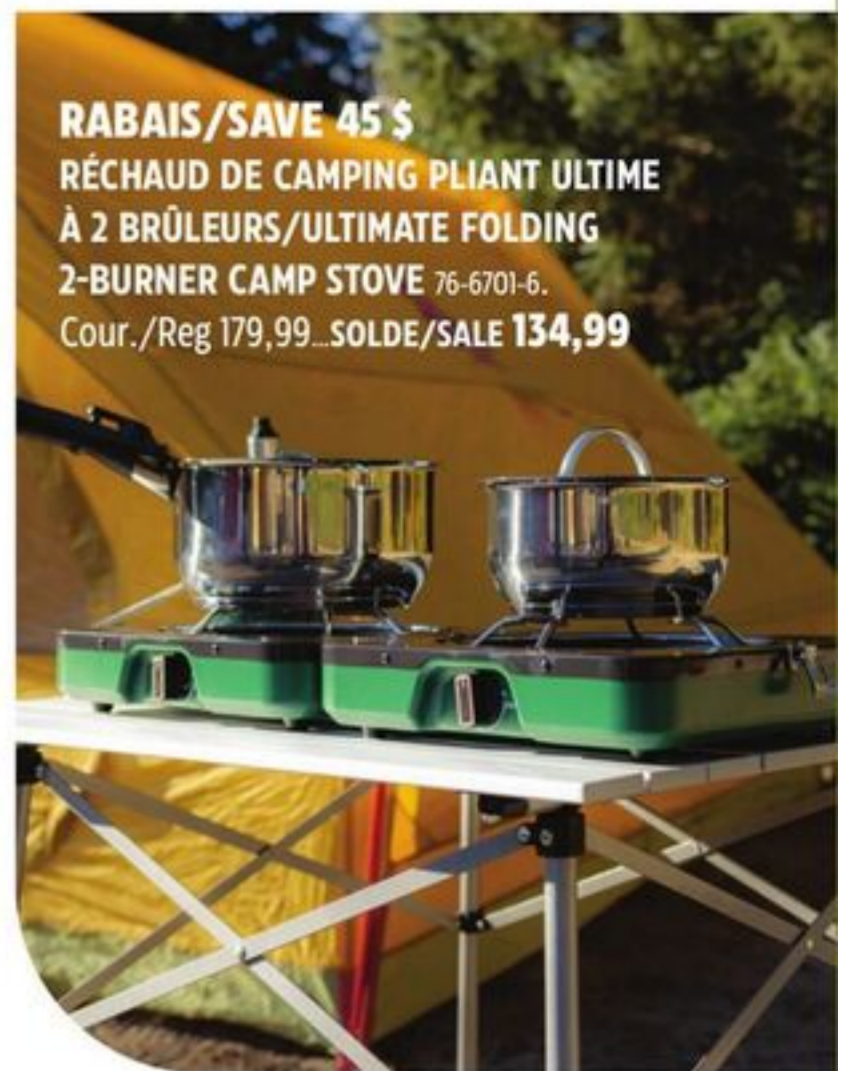

RABAIS/SAVE 45 \$
RÉCHAUD DE CAMPING PLIANT ULTIME
À 2 BRÔLEURS/ULTIMATE FOLDING
2-BURNER CAMP STOVE 76-6701-6.
Cour./Reg 179,99...SOLDE/SALE 134,99

OUTBOUND™



3. FAUTEUIL PLIANT GENRE METTEUR EN SCÈNE OUTBOUND POUR ENFANTS/
OUTBOUND KIDS' FOLDING DIRECTOR'S CHAIR 76-6187-0...24,99

CERTAINS ARTICLES DE CAMPING/SELECTED CAMPING EQUIPMENT 76-2481X...12,99-79,99

4. ACHAT SPÉCIAL/SPECIAL BUY CAUSEUSE DE CAMPING OUTBOUND/OUTBOUND LOVESEAT
CAMP CHAIR 399-6270-2...59,99 Jusqu'à épuisement des stocks./While quantities last.

5. RÉCHAUD AU BUTANE AVEC COFFRET/BUTANE STOVE WITH CASE 76-5616-6...22,99
Bouteille de combustible/Fuel/propane tank not included.

RABAIS/SAVE 75 \$ CHARIOT UTILITAIRE OUTBOUND/OUTBOUND UTILITY WAGON
76-3718-6. Cour./Reg 184,99...SOLDE/SALE 109,99

Tommy Bahama



PARASOL DE 6 PI AVEC
ANCRAGE À SABLE
INTÉGRÉ/6' UMBRELLA
WITH INTEGRATED SAND
ANCHOR 176-0114-2...39,99
CERTAINS FAUTEUILS OU
CHARIOT DE PLAGE/
SELECTED BEACH
CHAIRS OR CART
176-0021X...79,99-99,99



NITE IZE



6. MICRO LANTERNE RECHARGEABLE RADIANT/
RADIANT RECHARGEABLE MICRO LANTERN
176-0054-4...25,99

7. MINI LAMPE DE POCHE RADIANT, 3 EN 1/RADIANT
3-IN-1 MINI FLASHLIGHT 176-0055-2...16,99

8. LAMPE FRONTALE RECHARGEABLE RH1
POWERSWITCH RADIANT/RADIANT RH1 POWERSWITCH
RECHARGEABLE HEADLAMP 176-0060-8...54,99

9. TENDEUR DE CORDE EN ALUMINIUM CAMJAM XT/
CAMJAM XT ALUMINUM ROPE TIGHTENER
176-0069-0...21,99

10. SYSTÈME D'ARRIMAGE DUAL CAMJAM, 8 PI/
DUAL CAMJAM TIE DOWN SYSTEM, 8' 176-0068-2...24,99

11. SYSTÈME D'ORGANISATION GEARLINE, 4 PI/
GEARLINE ORGANIZATION SYSTEM, 4' 176-0071-2...27,99
CERTAINS ACCESSOIRES DE CAMPING/SELECTED
CAMPING ACCESSORIES 176-0050X...11,49-79,99





1. BOUTEILLES À EAU, GOBELETS, TASSES, GLACIÈRES ET BAC Certaines couleurs et formats./ WATER BOTTLES, TUMBLERS, MUGS, COOLERS AND TOTE Selected sizes and colours. 176-0158X...**34,99-99,99**
2. BOUTEILLES À EAU, GOBELET ET TASSE/WATER BOTTLES, TUMBLER AND MUG 176-0086X...**34,99-59,99**
3. GLACIÈRE SOUPLE ISOLANTE COMPACTE CARRYOUT™, 10 L/CARRYOUT™ COMPACT INSULATED SOFT COOLER, 10L 176-0084-2...**119,99**
4. TASSE DE VOYAGE ISOLANTE EN ACIER INOXYDABLE, 12 OZ./STAINLESS-STEEL INSULATED TRAVEL COFFEE MUG, 12-OZ 176-0088-4...**34,99**
5. GOURDE DE VOYAGE ISOLANTE EN ACIER INOXYDABLE AVEC BOUCHON SOUPLE, 24 OZ./STAINLESS-STEEL INSULATED TRAVEL WATER BOTTLE WITH FLEX STRAW CAP, 24-OZ 176-0091-4...**47,99**
6. GOURDE DE VOYAGE ISOLANTE EN ACIER INOXYDABLE AVEC BOUCHON SOUPLE, 32 OZ./STAINLESS-STEEL INSULATED TRAVEL WATER BOTTLE WITH FLEX STRAW CAP, 32-OZ 176-0179-8...**59,99**



NINJA



- RABAIS/SAVE 50 \$**
 GLACIÈRE RIGIDE PORTATIVE FROSTVAULT AVEC TIROIR DRYCHILL, BLEU, 47 L/ BLUE FROSTVAULT PORTABLE HARD TRAVEL COOLER WITH DRYCHILL DRAWER, 47L 85-4324-4. Cour./Reg 329,99
SOLDE/SALE 279,99
- RABAIS/SAVE 70 \$**
 GLACIÈRE SUR ROUES, 42,5 L Blanc./WHEELED COOLER, 42.5L White. 85-4333-2. Cour./Reg 399,99...**SOLDE/SALE 329,99**

Les indispensables de l'hydratation

Hydration heroes



Sans BPA/BPS, va au lave-vaisselle, étanche
 BPA/BPS Free, Dishwasher Safe, Leakproof



7. **RABAIS/SAVE 20 %** GOURDE SILO SUSTAINABLE, 48 OZ/ 48-OZ SILO SUSTAINABLE 76-3768-6. Cour./Reg 24,99...**SOLDE/SALE 19,99**
8. **RABAIS/SAVE 20 %** BOUTEILLE À EAU À GRAND GOULOT NALGENE, 32 OZ/ 32-OZ NALGENE WIDE MOUTH WATER BOTTLE 76-6366-4. Cour./Reg 19,99...**SOLDE/SALE 15,99**
- RABAIS/SAVE 20 %** CERTAINES BOUTEILLES À EAU/SELECTED WATER BOTTLES 76-3754X. Cour./Reg 19,99-24,99...**SOLDE/SALE 14,99-19,99**



9. **FILTRE GO OU PAILLE FILTRE À EAU PERSONNELLE PEAK LIFESTRAW** Soyez prudent, pensez à Lifestraw. Protège contre 99,99 % des bactéries, des parasites, des produits chimiques, du chlore et des microplastiques./**LIFESTRAW GO FILTER OR PEAK PERSONAL STRAW** Stay Safe, Pack a Lifestraw. Protects against 99.99% of bacteria, parasites, chemicals, chlorines and microplastics. 76-6560X...**34,99** ch./ea
10. **BOUTEILLE D'EAU GO LIFESTRAW, 1 L Noir ou blanc./LIFESTRAW GO WATER BOTTLE, 1L Black or white.** 76-6558X...**69,99** ch./ea





Confort au camping

Cuisinez, dormez, explorez, nous avons tout ce qu'il faut pour vos aventures en plein air.



Camp cozy

Cook, sleep, explore, we've got outdoor readiness covered.

AeroPress



RABAIS/SAVE 25 %

1. CAFETIÈRE DE VOYAGE PORTATIVE GO AEROPRESS/AEROPRESS GO TRAVEL COFFEE MAKER 76-6538-6. Cour./Reg 69,99...**SOLDE/SALE 51,99**
2. CAFETIÈRE ORIGINALE AEROPRESS/AEROPRESS ORIGINAL COFFEEMAKER 76-6539-4. Cour./Reg 54,99...**SOLDE/SALE 39,99**



RABAIS/SAVE 40 %

- RÉCHAUD DE CAMPING À 2 BRÛLEURS/DOUBLE-BURNER CAMP STOVE** 76-5809-8. Cour./Reg 84,99...**SOLDE/SALE 49,99**
Bouteille de combustible/propane non comprise./Fuel/propane tank not included.

24 Pces
24-pc



- RABAIS/SAVE 20 % VAISSELLE DE CAMPING EN ACIER INOXYDABLE, 24 PCES/24-PC STAINLESS-STEEL CAMPING DINNERWARE SET** 76-3273-2. Cour./Reg 63,99...**SOLDE/SALE 49,99**
BATTERIE DE CUISINE POUR CAMPING EN INOX, 8 PCES/ 8-PC STAINLESS-STEEL CAMPING COOKWARE SET 76-6569-2...**59,99**



RABAIS/SAVE 35 %

- CAFETIÈRE À FILTRE/ POUR OVER COFFEE POT** 76-6503-8. Cour./Reg 54,99...**SOLDE/SALE 34,99**



RABAIS/SAVE 30 %

- LANTERNES À DEL, 3/PAQ./ 3-PACK LED LANTERNS** 76-5617-4. Cour./Reg 26,99...**SOLDE/SALE 18,49**



Savourez l'aventure

Emportez un choix savoureux de plats gastronomiques prêts à déguster : il suffit d'ajouter de l'eau.

Savour adventure

Pack up a flavourful selection of ready-to-eat gourmet meals – just add water.



3. SPAGHETTIS À LA SAUCE NAPOLITAINE, 180 G/NEAPOLITAN SPAGHETTI, 180G 76-6767-0...**16,99**
4. FESTIN MAROCAIN, 175 G/MOROCCAN FEAST, 175G 76-6783-0...**16,99**

CERTAINS REPAS POUR LE CAMPING/SELECTED CAMPING MEALS 76-6768X...**10,99-21,99**

5. DÉLICE TROPICAL SMOOTH-EASE, 40 G/SMOOTH-EASE TROPICAL DELIGHT, 40G 176-0014-0...**4,59**
6. SOUPE RANCHERO, 70 G/RANCHERO SOUP, 70G 176-0168-4...**10,99**
7. MIJOTÉ DE BŒUF AUX LÉGUMES ET POMMES DE TERRE, 145 G/BEEF STEW WITH VEGETABLES AND POTATOES, 145G 176-0169-2...**19,99**
8. SOUPE THAÏE À LA NOIX DE COCO, 90 G/COCONUT THAI SOUP, 90G 176-0170-6...**11,99**
9. COUSCOUS AUX FRUITS D'ÉTÉ, 105 G/MERRY BERRY COUSCOUS, 105G 176-0174-8...**8,99**
10. PORC BRAISÉ AVEC SAUCE AUX CHAMPIGNONS ET VIN BLANC, 150 G/ BRAISED PORK WITH WHITE WINE MUSHROOM SAUCE, 150G 176-0167-6...**18,99**

CERTAINS REPAS ET BOISSONS POUR LE CAMPING/SELECTED CAMPING MEALS AND BEVERAGES 176-0001X...**4,59-19,99**





**RABAIS
SAVE
130 \$**

**DÉTECTEUR DE MÉTAL
ELITE/ELITE METAL
DETECTOR 79-4205-4.
Cour./Reg 649,99
SOLDE/SALE 519,99**



**RABAIS JUSQU'À/SAVE UP TO 50 \$ CERTAINS DÉTECTEURS DE MÉTAUX/
SELECTED METAL DETECTORS 79-4202X. Cour./Reg 199,99-249,99...SOLDE/SALE 159,99-199,99**



**1. RABAIS/SAVE 110 \$ DÉTECTEUR DE MÉTAL AUTOMATIQUE
VANQUISH 540/VANQUISH 540 AUTOMATIC
METAL DETECTOR 79-4204-6. Cour./Reg 549,99...SOLDE/SALE 439,99**
**2. RABAIS/SAVE 100 \$ DÉTECTEUR DE MÉTAL VANQUISH 440/VANQUISH
440 METAL DETECTOR 79-2213-6. Cour./Reg 479,99...SOLDE/SALE 379,99**
**RABAIS/SAVE 130 \$ DÉTECTEUR DE MÉTAL VANQUISH 340/
VANQUISH 340 METAL DETECTOR 79-2217-8.
Cour./Reg 379,99...SOLDE/SALE 249,99**



Déterminez rapidement et avec précision les pièces, les bagues et l'or./Locate coins, rings & gold with speed & accuracy.

**3. LOCALISATEUR PROFOND PINPOINTER/
PROFOND PINPOINTER 79-2244-2...119,99**
**4. LOCALISATEUR PINPOINT FINDER 35/
PINPOINT FINDER 35 79-4206-2...149,99**



Étui inclus./
Holster included.



**5. MATELAS DE CAMPING ISOLÉ KLYMALOFT/
INSULATED KLYMALOFT SLEEPING PAD 176-0031-8...289,99**
6. MATELAS DE CAMPING STATIC V/STATIC V SLEEPING PAD 176-0033-4...89,99
7. MATELAS DE CAMPING ISOLÉ STATIC V/INSULATED STATIC V SLEEPING PAD 176-0036-8...129,99

**8. MATELAS DE CAMPING ISOLÉ DOUBLE V/
INSULATED DOUBLE V SLEEPING PAD 176-0042-2...194,99**
9. OREILLER X/PILLOW X 176-0043-0...29,99
10. OREILLER LUXE/LUXE PILLOW 176-0045-6...54,99

CERTAINS TAPIS DE SOL, OREILLERS OU POMPE ÉLECTRIQUE/SELECTED SLEEPING PADS, PILLOWS OR ELECTRIC PUMP 176-0028X...39,99-259,99



L'aventure vous appelle

Avec un peu de préparation, vous dormirez confortablement à la belle étoile.

Camping's calling

With a little prep, you'll be sleeping under the stars in comfort.

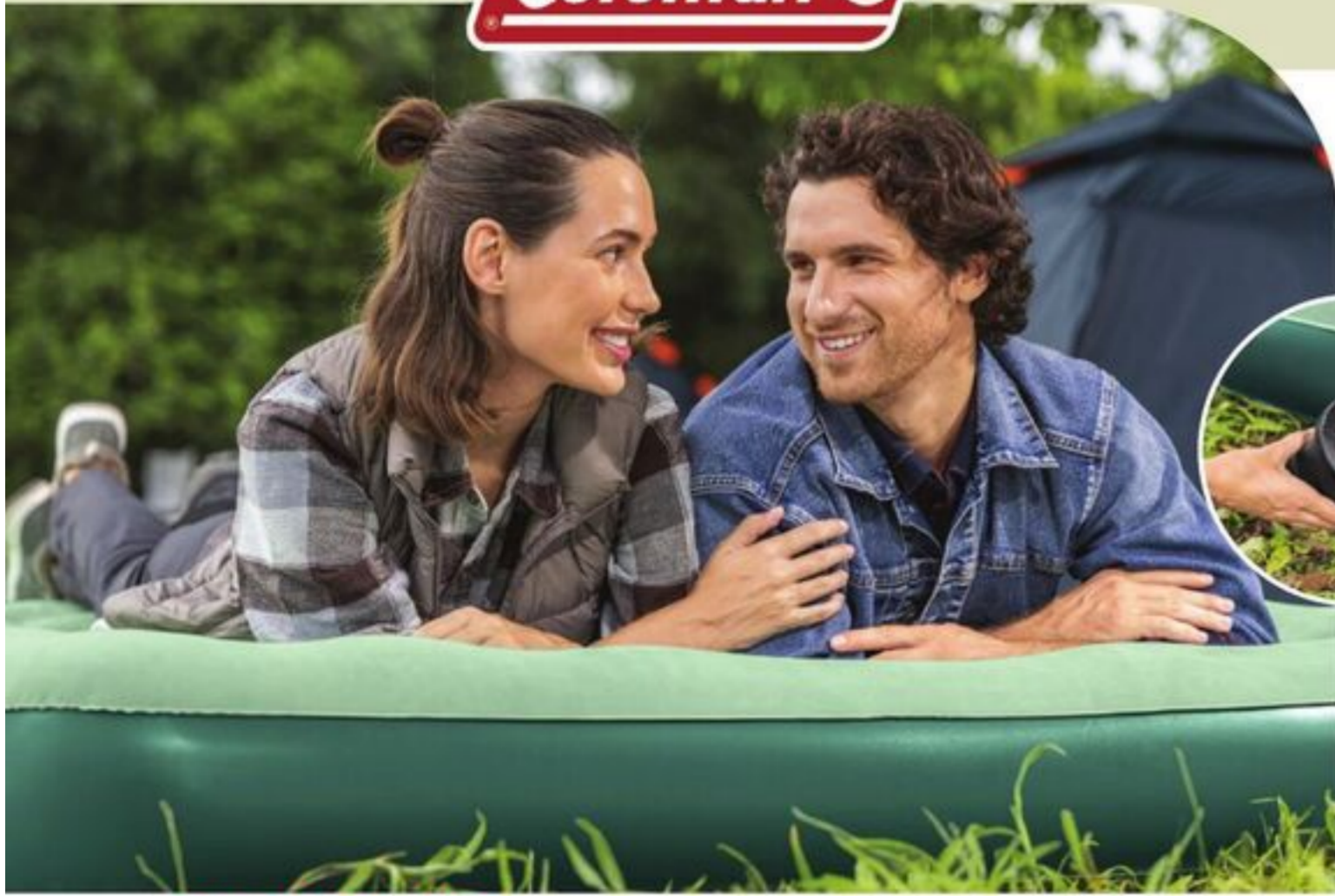

1. RABAIS/SAVE 30 % MATELAS PNEUMATIQUE UNE HAUTEUR QUICKBED, GRAND DEUX PLACES/QUICKBED SINGLE-HIGH QUEEN AIR BED 76-6892-0. Cour./Reg 119,99...**SOLDE/SALE 83,99**

MATELAS DEUX PLACES OU UNE PLACE/TWIN OR DOUBLE SIZE 76-6890X. Cour./Reg 99,99-104,99...**SOLDE/SALE 69,99-72,99**

2. RABAIS/SAVE 85 \$ MATELAS PNEUMATIQUE DEUX HAUTEURS GUESTREST, GRAND DEUX PLACES/GUESTREST DOUBLE-HIGH QUEEN AIR BED 76-6894-6. Cour./Reg 279,99...**SOLDE/SALE 194,99**

RABAIS/SAVE 75 \$ FORMAT UNE PLACE/TWIN SIZE 76-6893-8. Cour./Reg 249,99...**174,99**

Se gonfle en seulement 3 à 4 minutes grâce à la pompe à batterie portative, idéal pour le camping.
Inflates in only 3-4 min. with the handheld battery pump – perfect for camping.



RABAIS/SAVE 60 \$ RÉCHAUD DE CAMPING CASCADE 222/CASCADE 222 CAMP STOVE 76-3752-2. Cour./Reg 209,99 **SOLDE/SALE 149,99**

RABAIS/SAVE 80 \$ RÉCHAUD DE CAMPING À 3 BRÛLEURS 328/328 3-BURNER CAMP STOVE 76-6548-2. Cour./Reg 279,99...**SOLDE/SALE 199,99**
Bouteille de carburant/de propane non comprise./ Fuel/propane tank not included.



CERTAINS RÉCHAUDS DE CAMPING/SELECTED CAMP STOVES 176-0104X. **104,99-339,99**
Bouteille de carburant/de propane non comprise./ Fuel/propane tank not included.



3. GLACIÈRE RIGIDE, 66 L/66L HARD COOLER 85-4254-0...**159,99**



4. GLACIÈRE RIGIDE SUR ROUES PRO, 55 PTE/55-QT PRO WHEELED HARD COOLER 185-5502-6...**349,99**

RABAIS JUSQU'À/SAVE UP TO 20 \$ CERTAINES GLACIÈRES SOUPLES/SELECTED SOFT COOLERS 85-2187X. Cour./Reg 52,99-65,99...**SOLDE/SALE 36,99-45,99**
CERTAINES GLACIÈRES ET CRUCHES À BOISSONS/SELECTED COOLERS AND BEVERAGE JUGS 85-3435X/185-5500X...**52,99-329,99**



RABAIS JUSQU'À SAVE UP TO 60 \$
CERTAINES FAUTEUILS DE CAMPING OU CHARIOT/SELECTED CAMPING CHAIRS OR WAGON 76-1445X. Cour./Reg 49,99-179,99 **SOLDE/SALE 34,99-119,99**



CERTAINES LANTERNES/SELECTED LANTERNS 76-2786-8/176-0110X...**79,99-179,99**



RABAIS/SAVE 140 \$ ABRI MOUSTICHAIRE ONETOUCH, 15 X 13 PI/15 X 13' ONETOUCH SCREEN HOUSE 76-6464-0. Cour./Reg 539,99...**SOLDE/SALE 399,99**

RABAIS JUSQU'À/SAVE UP TO 160 \$ ABRI OU TENTE POUR 8 PERSONNES/CANOPY OR 8-PERSON TENT 76-6126X. Cour./Reg 289,99-399,99...**SOLDE/SALE 139,99-239,99**



CERTAINES TENTES/SELECTED TENTS 76-6129-0/176-0108X...**189,99-699,99**

LANTERNE CLASSIQUE COLEMAN/COLEMAN CLASSIC LANTERN 76-6555-4. **69,99**



RALEIGH

Puissant moteur d'entraînement à moyeu de 500 W/Batterie de 14 Ah de grande capacité/Pneus surdimensionnés tout terrain de 26 x 4 po
Powerful 500W hub-drive motor/Large capacity 14Ah battery/26 x 4" all-terrain fat tires

**RABAIS SAVE 300 \$**

VÉLO ÉLECTRIQUE À PNEUS SURDIMENSIONNÉS QUANTA, 26 PO, VERT/ QUANTA ELECTRIC FAT TIRE BIKE, 26", GREEN

71-2085-6.
Cour./Reg 2809,99
SOLDE/SALE 2509,99*

Légende des vélos

Bike Features Legend



DIMENSION DES ROUES WHEEL SIZE



À SUSPENSION AVANT HARDTAIL



À DOUBLE SUSPENSION DUAL SUSPENSION



VÉLO ÉLECTRIQUE E-BIKES

**RALEIGH**

RABAIS/SAVE 350 \$ VÉLO POUR ADULTES RIDGE, 27,5 PO/ RIDGE ADULT BIKE, 27.5" 71-0131-8.
Cour./Reg 849,99...**SOLDE/SALE 499,99**

RABAIS JUSQU'À/SAVE UP TO 360 \$ CERTAINS VÉLOS POUR ADULTES/SELECTED ADULT BIKES 71-0132X.
Cour./Reg 799,99-899,99...**SOLDE/SALE 479,99-539,99**

**STRATUS**

RABAIS/SAVE 350 \$ VÉLO POUR ADULTES PARALLAX, 27,5 PO OU 29 PO/PARALLAX ADULT BIKE, 27.5" OR 29" 71-2056X. Cour./Reg 699,99

SOLDE/SALE 349,99 ch./ea

RABAIS/SAVE 300 \$ VÉLO ÉLECTRIQUE POUR ADULTES X-TRAIL, 27,5 PO/X-TRAIL ADULT ELECTRIC BIKE, 27.5" 71-0104-4. Cour./Reg 1309,99
SOLDE/SALE 1009,99*

**RALEIGH**

RABAIS/SAVE 30 \$ VÉLO POUR JEUNES GOAT, 20 PO/ GOAT YOUTH BIKE, 20" 71-0123-8.
Cour./Reg 379,99...**SOLDE/SALE 349,99**

**RALEIGH**

RABAIS/SAVE 20 \$ VÉLO POUR ENFANTS METEOR, 16 PO/METEOR KIDS' BIKE, 16" 71-2063-8.
Cour./Reg 299,99...**SOLDE/SALE 279,99**

RABAIS/SAVE 20 \$ VÉLO POUR JEUNES METEOR, 20 PO/METEOR YOUTH BIKE, 20" 71-2064-6.
Cour./Reg 359,99...**SOLDE/SALE 339,99**

SUPERCYCLE

RABAIS JUSQU'À/SAVE UP TO 50 % CERTAINES POMPES DE VÉLO/ SELECTED BIKE PUMPS 73-0521X.
Cour./Reg 21,99-28,99
SOLDE/SALE 9,99-24,99

CASQUES DE VÉLO CROSSTRAILS Certaines tailles./CROSSTRAILS BIKE HELMETS Selected sizes. 73-5202X.
Cour./Reg 29,99
SOLDE/SALE 27,99 ch./ea

RABAIS/SAVE 50 % CADENAS À CLÉ POUR VÉLO SUPERCYCLE, 10 MM X 5 PI/SUPERCYCLE BIKE KEY LOCK, 10MM X 5" 73-2456-0. Cour./Reg 21,99...**SOLDE/SALE 10,89**

RABAIS JUSQU'À/SAVE UP TO 10 % CERTAINES CADENAS POUR VÉLOS/SELECTED BIKE LOCKS 73-0289X. Cour./Reg 19,99-31,99...**SOLDE/SALE 17,99-28,99**



RABAIS/SAVE 10 \$ CASQUES DE VÉLO SWERVE Certaines tailles./SWERVE BIKE HELMETS Selected sizes. 73-1011X. Cour./Reg 54,99
SOLDE/SALE 44,99 ch./ea

**MOTOMASTER**

RABAIS/SAVE 20 % SAC DE TOIT, 10 PI/10 CU-FT CARGO BAG 40-1581-4. Cour./Reg 169,99...**SOLDE/SALE 135,99**

MODÈLES DE 15 PI' OU 18 PI'/ 15 CU-FT OR 18-CU-FT MODELS 40-1579X.
Cour./Reg 199,99-229,99
SOLDE/SALE 159,99-183,99

**SeaSucker**

RABAIS/SAVE 65 \$ PORTE-VÉLO À VENTOUSES/SUCTION ROOF RACK 40-1979-0.
Cour./Reg 679,99...**SOLDE/SALE 611,99**

RABAIS JUSQU'À/SAVE UP TO 135 \$ CERTAINS PORTE-VÉLOS/SELECTED BIKE CARRIERS 40-1839X. Cour./Reg 429,99-679,99
SOLDE/SALE 343,99-543,99

**YAKIMA**

CERTAINS PORTE-VÉLOS OU COFFRE DE TOIT/ SELECTED BIKE CARRIERS OR CARGO BOX 40-2219-4/140-0202X...**229,99-1049,99**

**RALEIGH**

RABAIS JUSQU'À/SAVE UP TO 120 \$ CERTAINS PORTE-VÉLOS/SELECTED BIKE CARRIERS 40-1927X. Cour./Reg 159,99-599,99
SOLDE/SALE 127,99-479,99

TESTÉ TESTED



Succès sur toute la ligne

Choisissez des leurres et des outils adaptés pour améliorer votre technique de pêche.

Reel winners

Up your fishing game with the right lures & tools.

SHIMANO

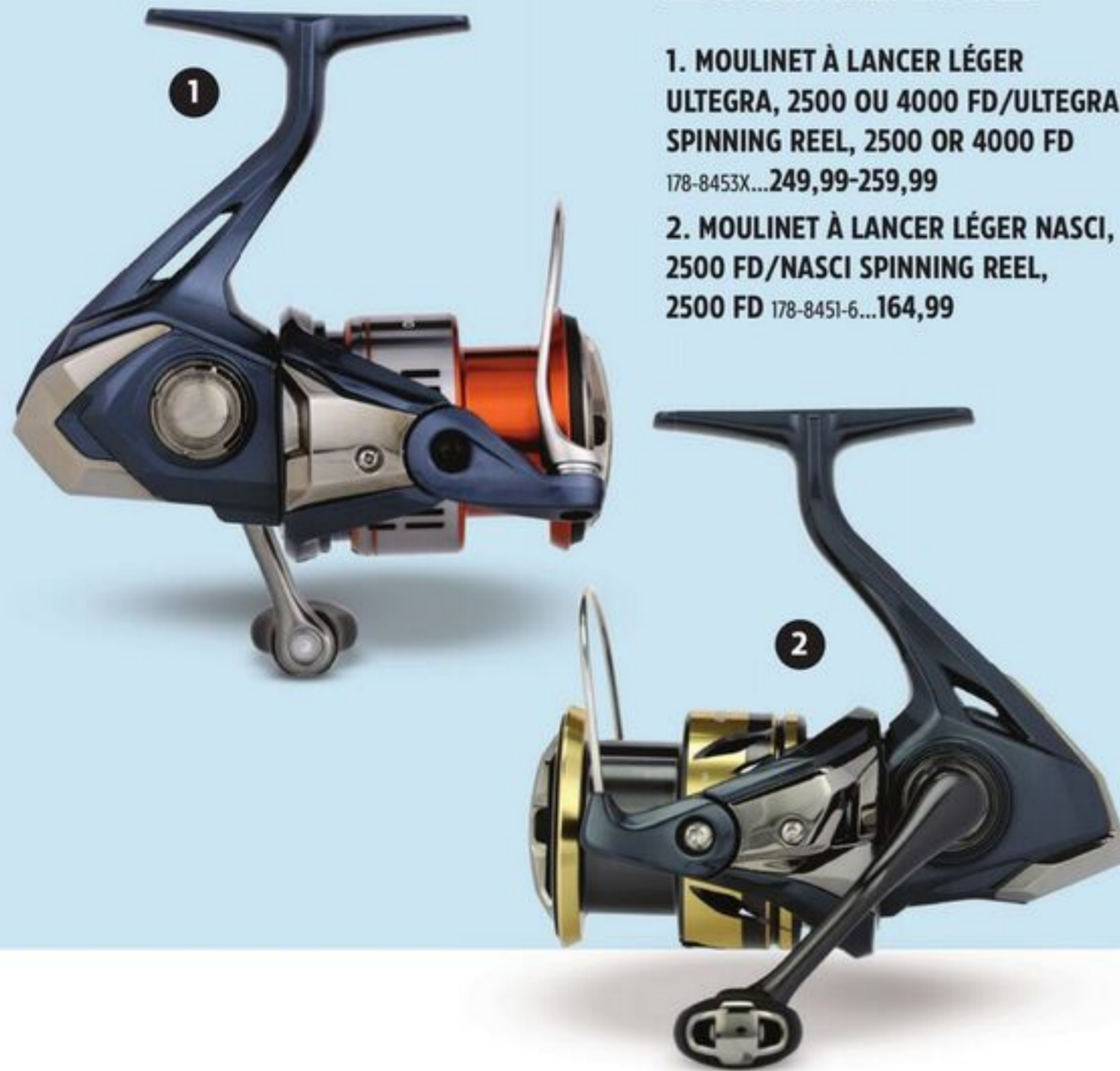

- 1. MOULINET À LANCER LÉGER ULTEGRA, 2500 OU 4000 FD/ULTEGRA SPINNING REEL, 2500 OR 4000 FD 178-8453X...249,99-259,99
- 2. MOULINET À LANCER LÉGER NASCI, 2500 FD/NASCI SPINNING REEL, 2500 FD 178-8451-6...164,99

- 3. ENS. À LANCER LÉGER SYMMETRY, 7 PI, MOYEN/SYMMETRY SPINNING COMBO, 7', MEDIUM 277-0897-8...149,99

- 4. ENS. À LANCER LÉGER SIENNA, 7 PI, MOYEN/SIENNA SPINNING COMBO, 7', MEDIUM 277-0821-8...89,99



- 5. CANNES POUR DORÉ JAUNE COMPRE, OFFERTES EN 6 PI 3 PO, 6 PI 8 PO MOYEN-LOURD ET 7 PI 1 PO MOYEN/COMPRE WALLEYE RODS, AVAILABLE IN 6'3", 6'8" MEDIUM HEAVY AND 7'1" MEDIUM 178-8455X...149,99 ch./ea
- 6. CANNE POUR PÊCHE À LA TRAÎNE COMPRE, 8 PI 6 PO, MOYEN-LOURD/COMPRE TROLLING ROD, 8'6", MEDIUM-HEAVY 178-8459-0...149,99
- 7. CANNE À LANCER TÉLESCOPIQUE COMPRE, 9 PI, LOURD/COMPRE TELESCOPIC CASTING ROD 9', HEAVY 178-8462-0...274,99

GARMIN

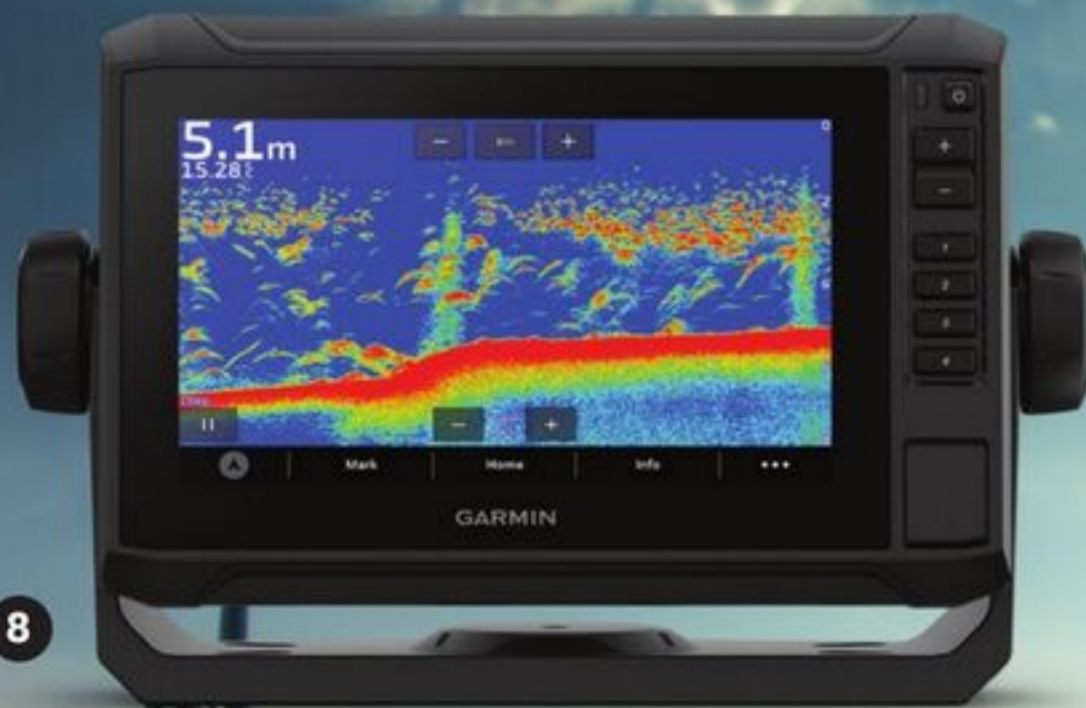

- 8. TRACEUR AVEC ÉCRAN TACTILE ECHOMAP UHD2, 7 PO Traceur à écran tactile de 7 po avec cartes Navionics+ GARMIN du Canada intégrées et transducteur GT56UHD./ECHOMAP UHD2 TOUCHSCREEN CHARTPLOTTER, 7" 7" Touchscreen chartplotter with built-in Canada Garmin Navionics+ maps and GT56UHD transducer. 178-7546-8...1529,99

- 9. DISPOSITIF ECHOMAP™ ULTRA 2 LIVESCOPE PLUS, 10 PO Donnez une nouvelle profondeur à vos parties de pêche grâce à notre ensemble tout-en-un ECHOMAP Ultra 2 et Livescope Plus, conçu pour offrir une clarté de sonar inégalée, une cartographie précise et une intégration parfaite. Cet ensemble performant affiche en temps réel des images sonar des poissons, des structures et de vos leurres dans les moindres détails sur un écran tactile de 10 po./ECHOMAP™ ULTRA 2 LIVESCOPE PLUS BUNDLE, 10" Take your fishing to new depths with our all-in-one ECHOMAP Ultra 2 and Livescope Plus bundle, designed to deliver unmatched sonar clarity, precision mapping, and seamless integration. This powerful package provides real-time sonar views of fish, structure, and your lure in stunning detail on a 10" touchscreen. 178-8445-2...3999,99

- 10. TRACEUR AVEC ÉCRAN TACTILE ECHOMAP™ UHD2 SV ET TRANSDUCTEUR GT56UHD-TM, 9 PO Traceur à écran tactile de 9 po avec cartes Navionics+ GARMIN du Canada intégrées et transducteur GT56UHD./ECHOMAP™ UHD2 SV TOUCHSCREEN CHARTPLOTTER WITH GT56UHD-TM TRANSDUCER, 9" 9" Touchscreen chartplotter with built-in Canada Garmin Navionics+ maps and GT56UHD transducer. 178-7547-6...1889,99



L'article peut ne pas être offert dans certains magasins et peut nécessiter de 2 à 3 semaines pour être disponible./Products may not be available in all stores and may require 2-3 weeks for availability.



RABAIS
JUSQU'À
SAVE UP TO
40%



RABAIS
SAVE 40%
ENS. À LANCER
LÉGER BLACK MAX,
6 PI 6 PO, MOYEN/
BLACK MAX SPINNING
COMBO, 6'6", MEDIUM
277-0857-4.
Cour./Reg 89,99
SOLDE/SALE 53,99



RABAIS
SAVE 15%
ENS. À LANCER
LÉGER MAX SX,
6 PI 6 PO, MOYEN/
MAX SX SPINNING
COMBO 6'6" MEDIUM
277-0858-2.
Cour./Reg 129,99
SOLDE/SALE 110,49



RABAIS/SAVE 15%
ENS. À LANCER LOURD
MAX X EZ, 6 PI MOYEN/
MAX X EZ CAST BAITCAST
COMBO, 6' MEDIUM
178-8057-6. Cour./Reg 89,99
SOLDE/SALE 76,49



RABAIS/SAVE 20%
MOULINET À LANCER LOURD BLACK MAX,
DROITIER OU GAUCHER/BLACK MAX
BAITCAST REEL, RIGHT OR LEFT HANDED
277-0862x. Cour./Reg 99,99
SOLDE/SALE 79,99 ch./ea



RABAIS
SAVE 25%
MOULINET À
LANCER LÉGER
BLACK MAX,
3000/BLACK MAX
SPINNING REEL,
3000 277-0866-2.
Cour./Reg 69,99
SOLDE/SALE 52,49



MOULINET À LANCER LÉGER
PURSUIT V, 2500 OU 6000/
PURSUIT V SPINNING REEL,
2500 OR 6000™
277-0864X...99,99-129,99



3. ENS. CANNE ET MOULINET
RIVAL II LEVEL WIND, 6 PI 6 PO/
RIVAL II LEVEL WIND COMBO,
6'6" 178-8467-0...199,99
4. ENS. À LANCER LÉGER
PURSUIT V, 8 PI, MOYEN-LOURD/
PURSUIT V SPINNING COMBO,
8', MEDIUM-HEAVY
178-8465-4...149,99-179,99
5. CANNE À PÊCHE DE BATEAU
SQUALL IV, 8 PI 3 PO, 9 PI OU
10 PI/SQUALL IV BOAT ROD, 8'3",
9' OR 10' 277-0867X...119,99 ch./ea



1. MOULINET WARFARE II LEVEL WIND, POUR DROITIER OU GAUCHER/
WARFARE II LEVEL WIND REEL, RIGHT OR LEFT HANDED 178-8470X...199,99 ch./ea
2. MOULINET RIVAL II LEVEL WIND REEL, POUR DROITIER OU GAUCHER/
RIVAL II LEVEL WIND REEL, RIGHT OR LEFT HANDED 178-8468X...159,99 ch./ea



Équipez-vous

Les amoureux du plein air partent à l'aventure en s'équipant de la tête aux pieds.

Get in gear

Outdoor adventurers are ready to go with head-to-toe essentials.

Rapala



- 1. T-SHIRT CRUSH CITY, GRIS M ou TTG./CRUSH CITY T-SHIRT, GREY M or XXL. 178-8422X...**34,99** ch./ea
- 2. T-SHIRT, BLEU MARINE M, G ou TTG./T-SHIRT, NAVY M, L or XXL. 277-0739X...**34,99** ch./ea
- 3. T-SHIRT VMC, NOIR M, G ou TTG./VMC T-SHIRT, BLACK M, L or XXL. 178-8426X...**34,99** ch./ea
- 4. CHEMISE À MANCHES LONGUES CRUSH CITY, VERT M, G ou TTG./CRUSH CITY LONG-SLEEVE SHIRT, GREEN M, L or XXL. 178-8430X...**69,99** ch./ea
- 5. CHEMISE À MANCHES LONGUES, BLEU M, G, TG ou TTG./LONG-SLEEVE SHIRT, BLUE M, L, XL or XXL. 277-0747X...**69,99**
- 6. CHANDAIL À CAPUCHON SPLASH RED FLOATER, GRIS M ou TTG./RED FLOATER SPLASH HOODIE, GREY M or XXL. 277-0743X...**64,99** ch./ea



CERTAINES CASQUETTES DE PÊCHE/SELECTED FISHING CAPS 277-0751X...**29,99** ch./ea



- 7. CACHE-COU CRUSH CITY/CRUSH CITY NECK GAITER 178-8434-8...**16,49**
- 8. CACHE-COU 13 FISHING/13 FISHING NECK GAITER 178-8435-6...**16,49**
- 9. CACHE-COU VMC/VMC NECK GAITER 178-8436-4...**16,49**



**RABAIS
SAVE
25%**

- SAC DE PÊCHE DRIFT 3700/3700 DRIFT TACKLE BAG 277-0893-6. Cour./Reg 99,99...**SOLDE/SALE 74,99**
- SAC À DOS DE PÊCHE DRIFT 3600/3600 DRIFT TACKLE BACKPACK 277-0892-8. Cour./Reg 149,99...**SOLDE/SALE 112,49**

- RABAIS/SAVE 20%**
- PLATEAU À LEURRES TRANSPARENT 3600,4/PAQ./3600 SIZE CLEAR TACKLE TRAY, 4-PACK 277-0891-0. Cour./Reg 34,99...**SOLDE/SALE 27,99**
- PLATEAU À LEURRES TRANSPARENT 3700, 3/PAQ./3700 SIZE CLEAR TACKLE TRAY, 3-PACK 277-0890-2. Cour./Reg 34,99...**SOLDE/SALE 27,99**

*L'article peut ne pas être offert dans certains magasins et peut nécessiter de 2 à 3 semaines pour être disponible./*Products may not be available in all stores and may require 2-3 weeks for availability.



13 FISHING

1. **RABAIS/SAVE 30 \$** ENS. À LANCER LÉGER SYNC, 6 PI 6 PO, MOYEN-RAPIDE/SYNC SPINNING COMBO, 6'6", MEDIUM-FAST 277-0768-6. Cour./Reg 129,99...**SOLDE/SALE 97,49**
2. **RABAIS/SAVE 40 \$** ENS. À LANCER LÉGER TACT, 7 PI 1 PO, MOYEN-LÉGER/TACT SPINNING COMBO, 7'1", MEDIUM-LIGHT 277-0769-4. Cour./Reg 164,99...**SOLDE/SALE 123,74**
3. **RABAIS/SAVE 40 \$** ENS. À LANCER LÉGER VOID, 6 PI 6 PO, MOYEN-RAPIDE/VOID SPINNING COMBO, 6'6", MEDIUM-FAST 277-0767-8. Cour./Reg 99,99...**SOLDE/SALE 59,99**
4. **CANNES À LANCER LÉGER OATH, OFFERTES EN 7 PI 1 PO, PUISSANCE MOYENNE ET 6 PI 10 PO, PUISSANCE MOYENNE-LÉGÈRE/OATH SPINNING RODS, AVAILABLE IN 7'1" MEDIUM AND 6'10" MEDIUM LIGHT ACTIONS 178-8441X...139,99 ch./ea**
5. **CANNES À LANCER OATH, OFFERTES EN MOYEN-LOURD 7 PI 3 PO ET MOYEN-RAPIDE 7 PI 1 PO/OATH CASTING RODS, AVAILABLE IN 7'3" MEDIUM-HEAVY AND 7'1" MEDIUM-FAST ACTIONS 178-8443X...139,99 ch./ea**



Rapala



RABAIS/SAVE 40 % ENS. À LANCER LÉGER CLASSIQUE POUR DORÉ JAUNE, 7 PI 1 PO, MOYEN-LÉGER/CLASSIC WALLEYE SPINNING COMBO, 7'1", MEDIUM-LIGHT 277-0771-6. Cour./Reg 89,99...**SOLDE/SALE 53,99**

RABAIS/SAVE 40 % ENS. À LANCER LÉGER CLASSIQUE POUR BROCHET, 7 PI 2 PO, MOYEN-LOURD/CLASSIC PIKE SPINNING COMBO, 7'2", MEDIUM-HEAVY 277-0770-8. Cour./Reg 99,99...**SOLDE/SALE 59,99**

RABAIS SAVE 25 %
MOULINET À LANCER LÉGER CLASSIQUE, OFFERT EN 2000 OU 3000/CLASSIC SPINNING REEL, AVAILABLE IN 2000 AND 3000 SIZE 277-0772X. Cour./Reg 59,99-69,99 **SOLDE/SALE 44,99-52,49**



RABAIS/SAVE 20 %
ENS. À FILETER DU PÊCHEUR, 3 PCES Les outils qu'il faut pour fileter rapidement. Comprend un couteau à fileter de 6 po avec étui, un gant de filetage et une fourchette à fileter./**FISHERMAN'S FILLET COMBO, 3-PC** The right tools to make fast work of any filleting chore. Includes 6" Fillet Knife, with sheath, Fillet Glove and Fillet Fork. 277-0764-4. Cour./Reg 44,99...**SOLDE/SALE 35,99**

**Y avez-vous pensé
You might need this**

RABAIS/SAVE 20 %
TROUSSE D'OUTILS DU PÊCHEUR À LA LIGNE, 3 PCES Le choix d'outils tout indiqué pour chaque pêcheur. Comprend des ciseaux, une pince à pêche au flotteur et des pinces./**ANGLER'S TOOL KIT, 3-PC** The perfect selection of tools for every angler. Includes Scissors, Floating Fish Gripper and Pliers. 277-0763-6. Cour./Reg 39,99...**SOLDE/SALE 31,99**



HOUSSE POUR LEURRES RAPALA Disponible en format petit, moyen ou grand./**RAPALA LURE WRAP** Available in Small, Medium or Large sizes. 178-8437X...**8,99-11,99**



PROFISHIENCY®

1. **RABAIS/SAVE 20 %** ENS. À LANCER LÉGER SOGO, 6 PI 6 PO/SOGO SPINNING COMBO, 6'6" 277-0886-4. Cour./Reg 89,99...**SOLDE/SALE 71,99**

RABAIS/SAVE 20 % CERTAINS ENS. DE PÊCHE POUR JEUNES/SELECTED YOUTH FISHING COMBOS 77-2254X/277-0884X. Cour./Reg 29,99-149,99...**17,99-119,99**

2. **RABAIS/SAVE 20 %** ENS. À LANCER LÉGER RETRO, 7 PI, MOYEN-LOURD/RETRO SPINNING COMBO, 7', MEDIUM-HEAVY 77-3403-2. Cour./Reg 129,99 **SOLDE/SALE 103,99**

3. **RABAIS/SAVE 20 %** ENS. À LANCER LOURD NEXT GEN KRAZY 3, 5 PI 6 PO, MOYEN-LOURD/KRAZY 3 NEXT GEN BAITCAST COMBO, 5'6", MEDIUM-HEAVY 77-3401-6. Cour./Reg 149,99...**SOLDE/SALE 119,99**

4. SAC DE PÊCHE KRAZY 3/KRAZY 3 TACKLE BAG 77-3487-2... **69,99**



Conçus spécialement pour les jeunes pêcheurs, avec des poignées ergonomiques

Made specifically for young anglers with ergonomic grips

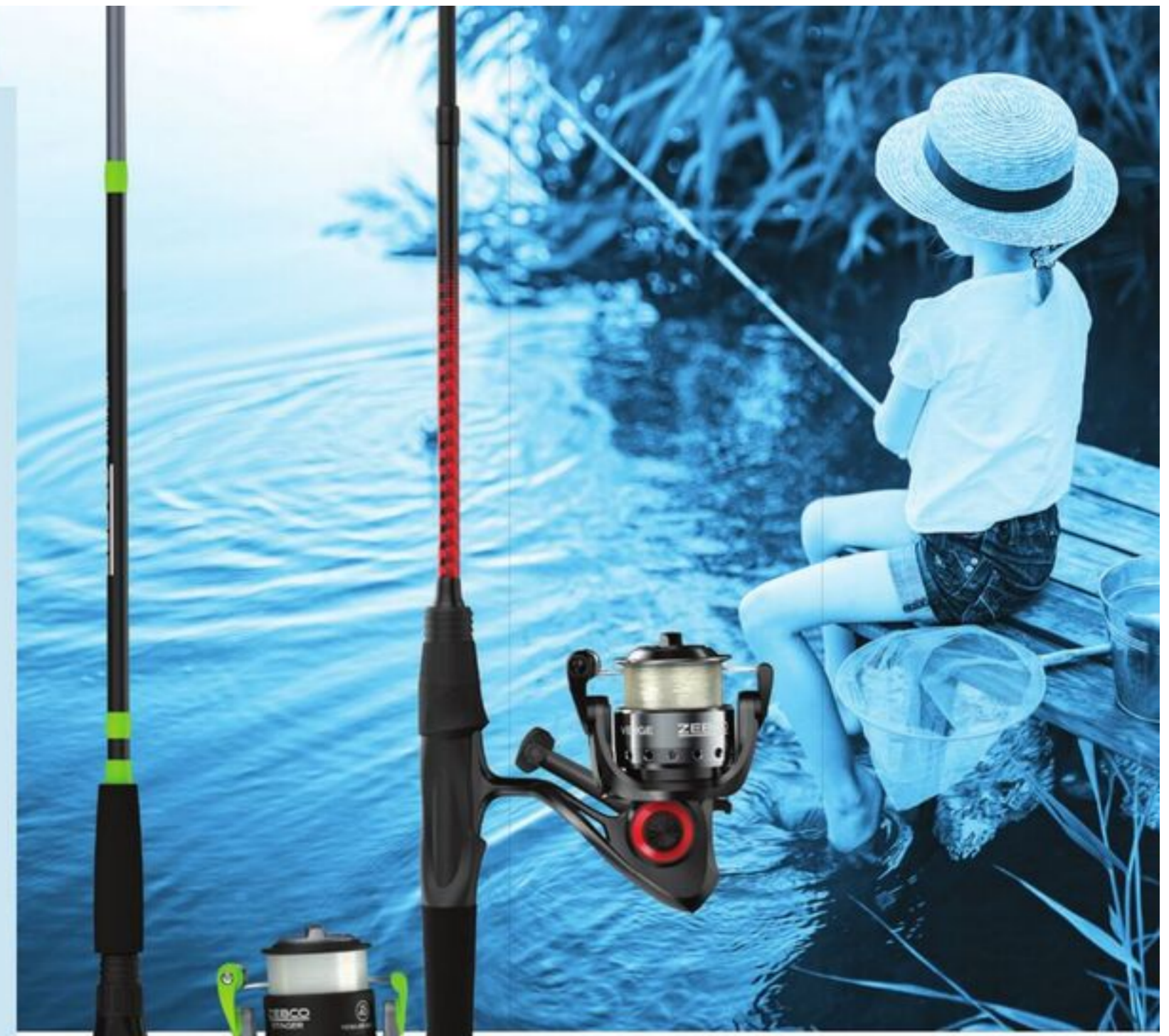

ZEBCO

5. ENS. À LANCER LÉGER STINGER, 7 PI/STINGER SPINNING COMBO, 7' 277-0881-4... **59,99**

6. **RABAIS/SAVE 20 %** ENS. À LANCER LÉGER VERGE, 6 PI 6 PO/VERGE SPINNING COMBO, 6' 6" 277-0880-6. Cour./Reg 69,99 **SOLDE/SALE 55,99**

RABAIS/SAVE 20 % ENS. À LANCER LÉGER VERGE, 6 PI 2 PO/VERGE SPINNING COMBO, 6' 2" 277-0879-2. Cour./Reg 64,99...**SOLDE/SALE 51,99**

BLACKTUSK FOOD CO.

RABAIS/SAVE 10 % ASSAISONNEMENT FISH FLAVRIN' / FISH FLAVRIN' SEASONING

7. ORIGINAL 277-0836-4. Cour./Reg 7,99...**SOLDE/SALE 6,99**

8. PÂTE À FRIRE À LA BIÈRE / BEER BATTER 277-0837-2. Cour./Reg 7,99...**SOLDE/SALE 6,99**

9. À L'AIL RÔTI AU BEURRE / GARLIC & BUTTER 277-0838-0. Cour./Reg 7,99...**SOLDE/SALE 6,99**

10. CAJUN 277-0839-8. Cour./Reg 7,99 **SOLDE/SALE 6,99**



105 Pces
105-pc



TROUSSE DE LEURRE,
105 PCES/105-PC TACKLE KIT
277-0896-0...**49,99**



Appâtez le poisson

Les poissons ne peuvent résister à notre gamme de leurres colorés et attrayants.

Take the bait

Fish can't resist our line of colourful, eye-catching lures.



1. ENS. LEURRES POUR ACHIGAN HAUL OF FAME, 39 PCES/39-PC BASS BAIT HAUL OF FAME KIT 277-0256-4...**59,99**

2. ENS. LEURRES POUR DORÉ JAUNE HAUL OF FAME, 56 PCES/56-PC WALLEYE BAIT HAUL OF FAME KIT 277-0257-2...**59,99**



3. LEURRE POWER VIBE, 2,25 PO Couleurs variées./
POWER VIBE, 2.25" Assorted colours. 277-0240X...**14,99** ch./ea

4. LEURRE POWER VIBE, 3,75 PO Couleurs variées./
POWER VIBE, 3.75" Assorted colours. 277-0246X...**15,99** ch./ea

5. LEURRE CHOP BLOCK, 8 PO Type variés./CHOP BLOCK, 8" Assorted
types. 178-8139X...**34,99** ch./ea

6. LEURRE MAXSCENT FLUX-GILL, 3,5 PO Couleurs variées./
MAXSCENT FLUX-GILL, 3.5" Assorted colours. 178-8135X...**13,99** ch./ea

7. LEURRE SCREAMIN' CHOPPO, 3,75 PO Couleurs variées./
SCREAMIN' CHOPPO, 3.75" Assorted colours. 277-0248X...**19,99** ch./ea



LEURRE SNAG
PROOF ZOO
WAKE, 3/8 OZ,
4,25 PO Couleurs
variées./
SNAG PROOF
ZOO WAKE,
3/8 OZ, 4.25"
Assorted colours.
277-0201X...**15,99** ch./ea



LEURRE NETBAIT
NANOSWIM, 2 PO
Couleurs variées./
NETBAIT
NANOSWIM, 2"
Assorted colours.
178-8245X...**6,99** ch./ea



8. LEURRE CRANKCASE,
2 3/8 PO Couleurs variées./
CRANKCASE, 2 3/8" Assorted
colours. 277-0380X...**9,99** ch./ea

9. LEURRE LONG HAULER,
3,5 PO Couleurs variées./
LONG HAULER, 3.5"
Assorted colours.
277-0416X...**11,99** ch./ea

10. HARNAIS À VER AVEC
HÉLICE, 1/4 OZ Couleurs
variées./FLY WHEEL WORM
HARNES, 1/4 OZ Assorted
colours. 277-0400X...**6,99** ch./ea



LEURRE SCUM FROG BASS RAT, 1/2 OZ,
2,5 PO Couleurs variées./SCUM FROG
BASS RAT, 1/2 OZ, 2.5" Assorted colours.
277-0197X...**10,99** ch./ea



LEURRE QUEUE DE
COO WORDEN'S, 6/PAQ. Certains types et
formats./WORDEN'S ROOSTER TAIL, 6-PACK
Selected types and sizes. 277-0193X...**29,99** ch./ea



11. LEURRE À ACTION
SACCADÉE WALLEYE
COUNTY PISTON,
4 PO Couleurs
variées./WALLEYE
COUNTY PISTON
JERKBAIT, 4"
Assorted colours.
277-0412X...**9,99** ch./ea

12. LEURRE FENDER
SHAD, 2,75 PO
Couleurs variées./
FENDER SHAD, 2.75"
Assorted colours.
277-0406X...**6,49** ch./ea



Gamakatsu



L'hameçon idéal pour vos plus belles prises, quel que soit le poisson./Snag your best fish, big or small, with the perfect hook.

HAMEÇONS ROUNDS POUR VER À TIGE DÉCALÉE
Certaines tailles./WORM OFFSET ROUND BEND
HOOKS Selected sizes. 277-0128X...**8,99** ch./ea

HAMEÇONS À PERLE NANO ALPHA
Certaines tailles./NANO ALPHA BEAD
HOOKS Selected sizes. 178-8110X...**7,49** ch./ea

HAMEÇONS EN PIEUVRE NANO ALPHA
Certaines tailles./NANO ALPHA OCTOPUS
HOOKS Selected sizes. 277-0120X...**7,49** ch./ea

HAMEÇONS À CÉILLET OUVERT
SIWASH Certaines tailles./
SIWASH OPEN EYE HOOKS
Selected sizes. 178-8102X...**7,99-8,99**

Une prise de rêve Ultimate catch

Rapala



- 1. LEURRE SNARE 50 Couleurs variées./SNARE 50 Assorted colours. 277-0304X...**11,99** ch./ea
- 2. LEURRE HARVEST SHAD Couleurs variées./HARVEST SHAD Assorted colours. 277-0286X...**10,99** ch./ea
- 3. LEURRE CLAPTAIL 110 Couleurs variées./CLAPTAIL 110 Assorted colours. 277-0270X...**29,99** ch./ea
- 4. LEURRE HUSKY JERK Couleurs variées./HUSKY JERK Assorted colours. 277-0274X...**12,49-13,99**
- 5. LEURRE SALÉ NEDROLL CRUSHCITY OU THE SUSPECT Couleurs variées./
CRUSHCITY SALTED NEDROLL OR THE SUSPECT Assorted colours. 178-8162X/277-0262X...**9,99** ch./ea
- 6. SAC RAPID PACK, PETIT/RAPID PACK, SMALL 277-0754-8...**19,99**
SAC OU SACOCHE RAPID PACK, GRAND/RAPID PACK OR POUCH, LARGE 277-0755X...**29,99** ch./ea



STH
SET THE HOOK

RABAIS/SAVE 15 %
APPÂT THE NEDDER NED SET THE HOOK, 15/PAQ./
SET THE HOOK THE NEDDER NED BAIT, 15-PK
277-0492-0. Cour./Reg 5,99...**SOLDE/SALE 4,99**



RABAIS/SAVE 15 %
LEURRE VAIRON QUEUE FENDUE SET THE HOOK,
12/PAQ./SET THE HOOK RIP SPLIT TAIL MINNOW,
12-PK 277-0484-0. Cour./Reg 6,49...**SOLDE/SALE 5,49**



RABAIS JUSQU'À/SAVE UP TO 15 %
APPÂT SET THE HOOK Certains types./
SET THE HOOK BAIT Selected types. 277-0451X.
Cour./Reg. 5,99-6,99...**SOLDE/SALE 4,99-5,99**



RABAIS/SAVE 40 \$

BOTTES DE RANDONNÉE IMPERMÉABLES POUR ADULTES GRANITE PEAK
 Certaines couleurs et pointures./**GRANITE PEAK WATERPROOF ADULT HIKING**
BOOTS Selected colours and sizes. 187-2783X. Cour./Reg 99,99...**SOLDE/SALE 59,99**



1. RABAIS/SAVE 25 % CHAUSSURES DE RANDONNÉE POUR HOMMES RUNDLE
 Certaines pointures./**MEN'S RUNDLE HIKER** Selected sizes. 187-0252X. Cour./Reg 79,99
SOLDE/SALE 59,99

2. RABAIS/SAVE 25 % VESTE IMPERMÉABLE BRAZEAU Certaines couleurs et tailles./
BRAZEAU WATERPROOF RAIN JACKET Selected colours and sizes. 187-4058X.
 Cour./Reg 89,99...**SOLDE/SALE 64,99 ch./ea**



3



4



3. RABAIS/SAVE 25 % BOTTES DE RANDONNÉE POUR FEMMES BLUE LODGE, COUPE MI-Haute Certaines pointures./
WOMEN'S BLUE LODGE MID HIKER
 Selected sizes. 187-4227X.
 Cour./Reg 99,99...**SOLDE/SALE 74,99**

4. RABAIS/SAVE 20 % CHAUSSURES DE RANDONNÉE BASSES POUR FEMMES BLACK LODGE Certaines pointures./
WOMEN'S BLACK LODGE LOW TOP HIKER
 Selected sizes. 187-4232X. Cour./Reg 89,99
SOLDE/SALE 67,99



CHANDAILS ET CALEÇONS BOXEUR POUR HOMMES RED LABEL HANES
 4/paq. ou 6/paq./**HANES MEN'S RED LABEL**
SHIRTS AND BOXER BRIEFS 4-pk or 6-pk.
 187-4281X...**21,97 ch./ea**



BOTTES POUR HOMMES TRETORN WELLINGTON Certaines pointures./
MEN'S TRETORN WELLINGTON BOOTS
 Selected sizes. 187-3885X...**119,99**



RABAIS/SAVE 20 % SANGLE RÉTRACTABLE POUR TABLEAU ARRIÈRE, 2/PAQ./RETRACTABLE TRANSOM STRAP, 2-PACK
 40-2933-2. Cour./Reg 57,99...**SOLDE/SALE 45,99**

RABAIS/SAVE 30 % CERTAINES SANGLES RÉTRACTABLES POUR TABLEAU ARRIÈRE OU SANGLE DE TREUIL/SELECTED TRANSOM STRAPS OR WINCH STRAP 40-2932X.
 Cour./Reg 22,99-42,99...**SOLDE/SALE 15,99-29,99**



RABAIS/SAVE 30 % SANGLE POUR PLAT-BORD DE BATEAU, 1000 LB, 2 PO X 16 PI/ 1000-LB MARINE GUNWALE STRAP, 2" X 16'
 40-2931-6. Cour./Reg 22,99...**SOLDE/SALE 15,99**



BATTERIES AGM ULTRA Scellées et sans entretien./**ULTRA AGM BATTERIES**
 Sealed and maintenance-free.
 10-2498X...**À PARTIR DE/FROM 309,99****



RABAIS/SAVE 20 % CHARGEURS DE BATTERIES SÉRIE PRÉCISION XPC Modèles offerts en 5/1 A, 10/2 A et 20/4 A/
PRECISION SERIES XPC BATTERY CHARGERS
 Available in 5/1A, 10/2A and 20/4A models. 11-2132X.
 Cour./Reg 84,99-174,99...**SOLDE/SALE 67,99-139,99**



Prenez et partez avec l'appli Canadian Tire

Get it & go with the CT app

Ramassez facilement vos commandes avec votre code QR.

Easily pick up orders with your QR code.

**Téléchargez/
Download Now**





Visez la cible

Stay on target

Maîtrisez l'art de la chasse en combinant arcs, lames et jumelles.

Master the hunt with a combo of bows, blades & binoculars.

BARNETT
SEND IT

HUNTSHIELD



1. FLÈCHES SLIPSTREAM JR./SLIPSTREAM JR. ARROWS 75-0944-6...**24,99**
ARC À POULIES TOMCAT G3/TOMCAT G3 COMPOUND BOW 75-0934-0...**134,99**
2. **RABAIS/SAVE 20 \$** ARC RECOURBÉ QUICKSILVER G3/QUICKSILVER G3 RECURVE BOW 75-0938-2. Cour./Reg 79,99 **SOLDE/SALE 59,99**
3. ARC À POULIES BANSHEE G3/BANSHEE G3 COMPOUND BOW 75-0936-6...**99,99**
CIBLES DE TIR, 3/PAQ./TARGET FACES, 3-PK 75-4677-8...**12,99**

4. ARC RECOURBÉ AVEC CIBLE LIL' BUCK/LIL' BUCK RECURVE COMBO WITH TARGET 75-0940-4...**49,99**
ENSEMBLE POUR ARC RECOURBÉ LIL' BUCK G3/LIL' BUCK G3 RECURVE BOW COMBO 75-0942-0...**29,99**
5. **RABAIS/SAVE 40 \$** ARC À POULIES VORTEX G3/VORTEX G3 COMPOUND BOW 75-0932-4. Cour./Reg 169,99...**SOLDE/SALE 129,99**

SUPPORT DE CIBLE POUR SAC DE TIR UNIVERSEL/ UNIVERSAL ARCHERY BAG TARGET STAND 75-0845-2...**99,99**



6. **RABAIS/SAVE 25 %** COUTEAU RAZOR XD2, 3 PO/RAZOR XD2 KNIFE, 3" 375-2246-2. Cour./Reg 79,99...**SOLDE/SALE 59,99**
7. **RABAIS/SAVE 25 %** COUTEAU RAZOR HTX, 3 PO/RAZOR HTX KNIFE, 3" 375-2247-0. Cour./Reg 79,99...**SOLDE/SALE 59,99**
8. **RABAIS/SAVE 35 %** COUTEAU RAZOR-LITE EDC/RAZOR-LITE EDC KNIFE 175-7060-8. Cour./Reg 54,99...**SOLDE/SALE 34,99**
9. **RABAIS/SAVE 35 %** COUTEAU ONYX™ EDC, 3,5 PO/ONYX™ EDC KNIFE, 3.5" 375-0535-6. Cour./Reg 39,99...**SOLDE/SALE 24,99**
10. **RABAIS/SAVE 50 %** COUTEAU AFFINITY, 3 PO/AFFINITY KNIFE, 3" 375-2248-8. Cour./Reg 39,99...**SOLDE/SALE 19,99**
11. **RABAIS/SAVE 30 %** LAMES DE RECHANGE RAZOR-LITE, 6/PAQ./RAZOR-LITE REPLACEMENT BLADES, 6-PK 175-7061-6. Cour./Reg 18,99...**SOLDE/SALE 12,99**



6. 4 lames dont 1 lame de scie/4 blades including 1 saw blade



8. 6 lames/6 blades



9. 3 lames/3 blades



7. 6 lames avec 7 accessoires de coupe/6 blades with 7 cutting attachments



10. 1 lame/1 blade

OUTBOUND



RABAIS JUSQU'À/SAVE UP TO 60 \$
CERTAINES JUMELLES/
SELECTED BINOCULARS
175-2439X. Cour./Reg 77,99-139,99
SOLDE/SALE 47,99-76,99

YUKON GEAR



12

12. **RABAIS/SAVE 50 %** JUMELLES RIDGELINE APX, 7 X 32 MM/RIDGELINE APX BINOCULARS, 7X 32MM 175-9470-0. Cour./Reg 49,99...**SOLDE/SALE 24,99**



13

13. **RABAIS/SAVE 10 \$** JUMELLES À PRISME EN TOIT AVEC LENTILLES À REVÊTEMENT MULTICOUCHE INTÉGRAL APX/APX ROOF PRISM FULLY MULTI-COAT BINOCULARS 375-0136-6. Cour./Reg 84,99...**SOLDE/SALE 74,99**

Grossissement 10 X et lentilles de 42 mm./10X magnification with 42mm objective lenses.

CELESTRON



RABAIS/SAVE 80 \$
TÉLESCOPE EXPLORASCOPE 60AZ/ EXPLORASCOPE 60AZ TELESCOPE 76-1080-2. Cour./Reg 179,99...**SOLDE/SALE 99,99**



**YUKON
GEAR**



1. SAC À DOS OXFORD, 30 L/
OXFORD 30L BACKPACK
275-9319-6...**99,99**
2. SAC À DOS DE RANDONNÉE
ANNAPOLIS, 29 L/ANNAPOLIS
29L DAYPACK 275-9316-2...**74,99**
3. SAC DE SPORT THOMPSON,
130 L/THOMPSON 130L DUFFLE BAG
275-9317-0...**84,99**
4. SAC DE SPORT THOMPSON, 74 L/
THOMPSON 74L DUFFLE BAG 275-9318-8...**69,99**
- SAC FOURRE-TOUT À CORDON DRAWSTRING OU SAC DE TERRAIN EDC/
DRAWSTRING STUFF BAG OR EDC FIELD PACK 75-0605X...**29,99-39,99**

DMT



5. AIGUISOIR BURST EDGESHARP/
EDGESHARP BURST SHARPENER
375-2345-6...**39,99**
6. AIGUISOIR PRO POCKETSHARP
EDGESHARP/EDGESHARP
POCKETSHARP PRO SHARPENER
375-2346-4...**14,99**
7. AIGUISOIR TRAC EDGESHARP/
EDGESHARP TRAC SHARPENER
375-2347-2...**9,99**
8. AIGUISOIR POLYVALENT PRO BENCH/
PRO BENCH MULTI-PURPOSE SHARPENER
75-0875-0...**29,99**
- AIGUISOIR POLYVALENT GLIDE-PRO/
GLIDE-PRO MULTI-PURPOSE SHARPENER
75-0873-4...**29,99**

HUNTSHIELD™



9. TROUSSE DE NETTOYAGE UNIVERSELLE POUR CARABINE, 23 PCES/23-PC UNIVERSAL RIFLE CLEANING KIT 75-1701-8...**29,99**
10. TROUSSE DE NETTOYAGE UNIVERSELLE Certains calibres./UNIVERSAL CLEANING KIT Selected calibres. 75-1703X...**19,99** ch./ea
11. TROUSSE DE NETTOYAGE UNIVERSELLE POUR FUSIL, CALIBRE 12 OU 20/
UNIVERSAL SHOTGUN CLEANING KIT, 12-GAUGE OR 20-GAUGE 75-1704X...**19,99** ch./ea
12. TROUSSE TOUT-EN-UN POUR NETTOYER LES ARMES À FEU AVEC COFFRET EN ALUMINIUM/ALL-IN-ONE GUN CLEANING KIT WITH ALUMINIUM CASE 75-1702-6...**49,99**

AMERISTEP

Ce printemps, visez dans le mille grâce à notre choix de carabines à air comprimé de dernière génération
Our selection of the latest Air Rifles will keep you on target this Spring

RABAIS/SAVE 60 \$
AFFÛT DE CHASSE
AU SOL FIELDVIEW
EXTREME POUR
3 PERSONNES/
FIELDVIEW
EXTREME
3-PERSON
GROUND BLIND
75-1809-4.
Cour./Reg 259,99
SOLDE/SALE 199,99



RABAIS JUSQU'À/SAVE UP TO 40 \$

13. CARABINE À AIR COMPRIMÉ NORTHERNAER AVEC CANON BASCULANT, CALIBRE .22/NORTHERNAER BREAK BARREL .22 CALIBER AIR RIFLE 75-8575-6. Cour./Reg 149,99...**SOLDE/SALE 109,99**

14. CARABINE À AIR COMPRIMÉ NORTHERNAER AVEC CANON BASCULANT ET RAIL PIC/NORTHERNAER BREAK BARREL AIR RIFLE WITH PIC RAIL 375-2143-6. Cour./Reg 169,99...**SOLDE/SALE 127,49**

15. PISTOLET À BALLE BB CANADIAN PRAIRIE RANGER NORTHERNAER, 2/PAQ./NORTHERNAER CANADIAN PRAIRIE RANGER BB GUN, 2-PK 375-2144-4. Cour./Reg 149,99...**SOLDE/SALE 112,49**

RABAIS/SAVE 50 \$ CARABINE À AIR COMPRIMÉ AVEC ARMEMENT À LEVIER OU CANON BASCULANT NORTHERNAER/NORTHERNAER UNDER-LEVER OR BREAK BARREL AIR RIFLE 75-8572X. Cour./Reg 199,99-269,99...**SOLDE/SALE 149,99-219,99**



**Paq. de 2
2-pack**



Au gré des flots Go with the flow

Mettez le cap sur le plaisir de la pêche en bateau, en kayak ou en canot.

Set a course for fun & fishing with boats, kayaks & canoes.

sundolphin



Coussinets de protection pour les cuisses
Protective thigh pads

**RABAIS
SAVE 200 \$**
KAYAK
ARUBA,
10 PI Capacité
de 245 lb max./ARUBA 10'
KAYAK Up to 245-lb capacity.
79-8335-0. Cour./Reg 499,99
SOLDE/SALE 299,99

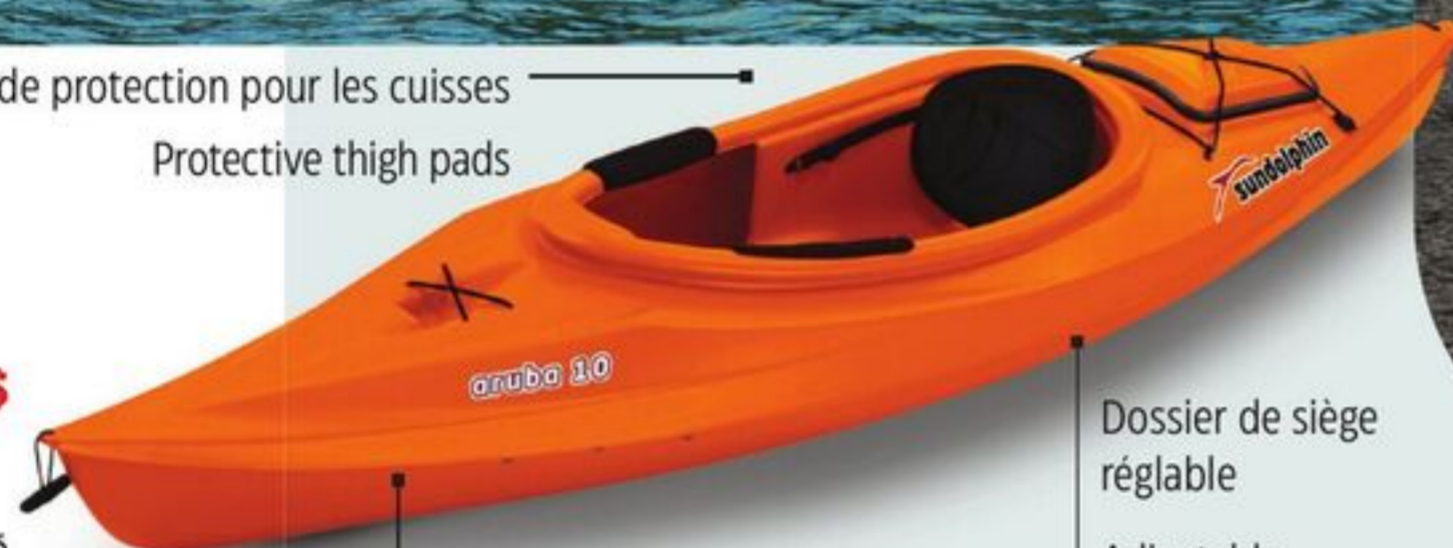

Dossier de siège
réglable
Adjustable
seat back

Porte-boisson moulé dans la coque
Molded-in bottle drink holder



sundolphin

RABAIS/SAVE 200 \$ KAYAK MUSKOKA, 10 PI Rotomoulé. Capacité de 300 lb max./MUSKOKA 10' KAYAK Roto-molded. Up to 300-lb capacity. 79-1225-4. Cour./Reg 699,99...**SOLDE/SALE 499,99**

sundolphin



BATEAU DE PÊCHE, 12 PI Capacité de 528 lb max./
12' JON BOAT Up to 528-lb capacity. 79-1226-2...**1099,99**



sundolphin

BlueLine MARINE



CHARIOT DE TRANSPORT POUR
KAYAK/CANOT/KAYAK/CANOE
CARRY CART 79-4106-0...**124,99**



CHARIOT DE TRANSPORT DROIT
POUR KAYAK/CANOT/KAYAK/CANOE
STRAIGHT CART 79-7302-4...**129,99**

FOX40
marine



TROUSSE D'ACCESSOIRES DE
SÉCURITÉ POUR BATEAU/
MARINE SAFETY KIT 79-0041-6...**10,99**

**RABAIS
SAVE 200 \$**
KAYAK DE PÊCHE
JOURNEY, 10 PI/
JOURNEY 10'
FISHING KAYAK
79-8336-8.
Cour./Reg 649,99
SOLDE/SALE 449,99





Propulsez vos aventures

Laissez-vous séduire par l'incomparable moteur hors-bord à arbre court : léger, portable et toujours fiable.

Power your voyage

Get hooked on the ultimate short shaft outboard motor – lightweight, portable and always reliable.



MOTEUR HORS-BORD À ARBRE COURT DE 9,9 HP / 9.9 HP SHORT SHAFT OUTBOARD MOTOR
79-9074-4...3759,99



MOTEUR HORS-BORD À ARBRE COURT DE 2,5 HP / 2.5 HP SHORT SHAFT OUTBOARD MOTOR 79-9072-8...1269,99



MOTEUR HORS-BORD À ARBRE COURT DE 6 HP / 6 HP SHORT SHAFT OUTBOARD MOTOR 79-9073-6...2199,99



RABAIS/SAVE 60 \$ HOUSSE DE BATEAU DE LUXE

12 à 14 pi./DELUXE BOAT COVER 12-14'. 79-1300-4.

Cour./Reg 169,99...SOLDE/SALE 109,99

RABAIS/SAVE 70 \$ MODÈLE DE 16 À 18 PI

OU 17 À 19 PI/16-18' OR 17-19' SIZE 79-1301-2/1302-0.

Cour./Reg 189,99-199,99...SOLDE/SALE 119,99-129,99



1. RABAIS/SAVE 20 % SIÈGE DE BATEAU PLIANT ROBUSTE, CADRE MOULÉ/HEAVY-DUTY MOULDED FRAME FOLDING BOAT SEAT 79-0077-2. Cour./Reg 99,99...SOLDE/SALE 79,99

RABAIS/SAVE 20 % SIÈGE DE BATEAU REMBOURRÉ, PLIANT/PADDED FOLDING BOAT SEAT 79-4402-4.

Cour./Reg 77,99...SOLDE/SALE 61,99

2. RABAIS/SAVE 20 % SIÈGE DE BATEAU, NOIR/BLACK BOAT SEAT 79-4425-0. Cour./Reg 144,99...SOLDE/SALE 111,99

3. RABAIS/SAVE 20 % SIÈGE DE BATEAU À HAUT DOSSIER EN VINYLE DE LUXE/DELUXE HI-BACK VINYL BOAT SEAT 79-4419-6. Cour./Reg 99,99...SOLDE/SALE 79,99

RABAIS JUSQU'À/SAVE UP TO 25 % CERTAINS SIÈGES DE BATEAU/SELECTED BOAT SEATS 79-4415X. Cour./Reg 84,99-129,99...59,99-103,99





Waboba®



1. BALLE BIG KAHUNA WABOBA/WABOBA BIG KAHUNA BALL 79-1312-6...14,99
2. BALLE PRO WABOBA/WABOBA PRO BALL 79-1306-2...18,99
3. BALLE MOON WABOBA/WABOBA MOON BALL 79-1314-2...13,99
4. BALLE BOLD WABOBA/WABOBA BOLD BALL 79-1304-6...16,99



1 gant
1-glove

GANT ATTRAPE-BALLE WABOBA
1 gant./WABOBA CATCH GLOVE
1 glove. 79-1310-0...49,99



Idéal pour les plaisanciers : le son puissant permet de vous faire entendre facilement en cas de sauvetage.

Perfect for boaters – emits a powerful blast, so you can be easily heard in a rescue situation.



- KLAXON PNEUMATIQUE, 3/PAQ./
SIGNAL AIR HORN, 3-PACK** 79-1268-2...39,99
MINI KLAXON PNEUMATIQUE/MINI AIR HORN 79-2710-2...12,99



- ARTICLES DE NETTOYAGE DU BATEAU** Certains types et formats./
BOAT CLEANING PRODUCTS Selected types and sizes. 79-2503X...17,99-26,99



**BROSSE UTILITAIRE POUR BATEAU
STARBRITE/STARBRITE UTILITY BOAT
BRUSH** 179-0220-2...17,99

**DÉSHUMIDIFICATEUR NO DAMP
STARBRITE, 12 OZ/STARBRITE NO DAMP
DEHUMIDIFIER, 12-OZ** 179-0210-6...9,99



**CERTAINS ARTICLES DE NETTOYAGE ET D'ENTRETIEN
DU BATEAU STARBRITE/SELECTED STARBRITE BOAT
CARE AND CLEANING PRODUCTS** 79-0090X...19,99-32,99
**NETTOYANT À VINYLE SIMONIZ POUR BATEAU, 473 ML/
SIMONIZ MARINE VINYL CLEANER, 473ML** 79-2511-6...14,99

**5. NETTOYANT/DÉSINFECTANT
NAUTIQUE DE SERVICE
INTENSIF SPRAY NINE, 946 ML/
SPRAY NINE MARINE HEAVY-DUTY
CLEANER/DISINFECTANT, 946ML**
79-0120-8...15,99

**NETTOYANT POUR COQUE DE
BATEAU SPRAY NINE, 946 ML/
SPRAY NINE MARINE BOAT
BOTTOM CLEANER,**
946ML 79-0175-8...18,99

**6. GRAISSE DIÉLECTRIQUE
MARINE PERMATÉX, 80 ML/
PERMATÉX MARINE
DIELECTRIC GREASE,
80ML** 79-0333-2...14,99



**RABAIS
SAVE 10 \$**
BATEAU GONFLABLE
KONDOR 2000 BESTWAY, 6 PI/
BESTWAY KONDOR 2000 INFLATABLE
BOAT, 6' 79-8324-6. Cour./Reg 29,99
SOLDE/SALE **19,99**



**RABAIS
SAVE 10 \$**
BATEAU GONFLABLE
KONDOR 3000 BESTWAY,
2 PERSONNES/BESTWAY KONDOR 3000
INFLATABLE BOAT, 2-PERSON 79-8365-8.
Cour./Reg 59,99...SOLDE/SALE **47,99**



RABAIS/SAVE 40 \$
BATEAU GONFLABLE HYDRO-FORCE VOYAGER
BESTWAY, 4 PERSONNES/BESTWAY HYDRO-FORCE
VOYAGER INFLATABLE BOAT, 4-PERSON 79-8349-8.
Cour./Reg 199,99...SOLDE/SALE **159,99**



RABAIS/SAVE 20 \$ BATEAU GONFLABLE Z-RAY TIDERUNNER 200, 2 PERSONNES/
Z-RAY TIDERUNNER 200 INFLATABLE BOAT, 2-PERSON 79-8367-4.
Cour./Reg 99,99...SOLDE/SALE **79,99**



COMELY



RABAIS/SAVE 200 \$ ENS. PLANCHE
DE SURF BLAZE Comprend planche de surf
et deux bottes./BLAZE WAKEBOARD SET
Includes wakeboard and 2 boots. 79-7192-4.
Cour./Reg 599,99...SOLDE/SALE **399,99**

RABAIS/SAVE 30 \$ PLANCHE À GENOUX
THEORY/THEORY KNEEBOARD 79-7187-8.
Cour./Reg 219,99...SOLDE/SALE **189,99**

Attaches
comprises
Includes
bindings



**SKI DE SLALOM NAUTIQUE BIG DADDY, TUNNEL
STANDARD/BIG DADDY STANDARD TUNNEL
SLALOM SKI 179-0119-6...479,99**

PLANCHE
POUR SURFER
DANS LE SILLAGE Pour
débutants/intermédiaires./
RIDE WAKESURF BOARD
For beginner/intermediate
riders. 179-0121-8...439,99



RABAIS/SAVE 30 \$
SKI NAUTIQUE POUR
ADULTES QUANTUM/
QUANTUM COMBO
ADULT WATER SKI
79-7195-8. Cour./Reg 299,99
SOLDE/SALE **269,99**

RABAIS/SAVE 30 \$
ENS. SKI NAUTIQUE
POUR ENFANTS/KIDS'
WATER SKI COMBO
79-7196-6. Cour./Reg 289,99
SOLDE/SALE **259,99**

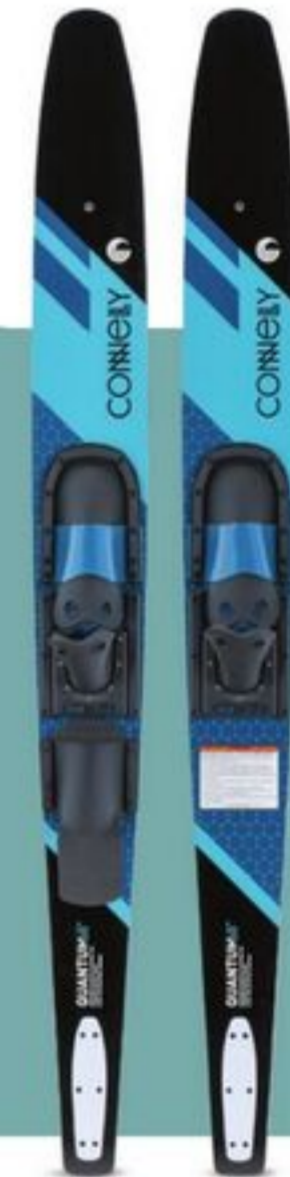

**RABAIS
SAVE 20 %**
PAGAIE DE CANOT
EN BOIS VERNI,
60 PO/VARNISHED
WOOD CANOE
PADDLE, 60"
79-1041-0.
Cour./Reg 32,99
SOLDE/SALE **25,99**



RABAIS/SAVE 20 % RAME VERNIE, 7 PI/
VARNISHED OAR, 7' 79-3311-6. Cour./Reg 62,99
SOLDE/SALE **49,99**
RABAIS/SAVE 20 % PAGAIE VERNIE 36 po,
48 po, 54 po ou 78 po./VARNISHED PADDLE 36",
48", 54" or 78". 79-1040X. Cour./Reg 32,99-62,99
SOLDE/SALE **25,99-49,99**



COMELY



**VFI EN NÉOPRÈNE POUR
ADULTES M, G ou TG./
NEOPRENE ADULT PFD
M, L or XL. 179-0200X.
154,99 ch./ea**



1. RABAIS/SAVE 30 \$ VFI À GONFLAGE AUTOMATIQUE/
MANUEL, 24 G/AUTO/MANUAL INFLATABLE PFD, 24G 79-2098-0.
Cour./Reg 219,99...SOLDE/SALE **186,99**

2. RABAIS/SAVE 30 \$ VFI À GONFLAGE AUTOMATIQUE,
24 G/AUTOMATIC INFLATABLE PFD, 24G 79-2099-8.
Cour./Reg 179,99...SOLDE/SALE **149,99**

RABAIS/SAVE 40 \$ VFI À GONFLAGE AUTOMATIQUE/MANUEL,
33 G/AUTO/MANUAL INFLATABLE PFD, 33G 79-2097-2.
Cour./Reg 259,99...SOLDE/SALE **219,99**



Tout pour le moteur

Que vous surriez sur les vagues ou que vous soyez sur la route, vous êtes fin prêt.

Motor must-haves

Whether you're riding waves or road-tripping, you're all set.



- 1. HUILE POUR MOTEUR DE BATEAU À 4 TEMPS PENNZOIL, 946 ML / PENNZOIL 4-CYCLE MARINE OIL, 946ML 28-1894-2...18,99
- 2. HUILE ENTIÈREMENT SYNTHÉTIQUE POUR MOTEUR DE BATEAU À 2 TEMPS XD100L, 3,78 L / MARINE XD100 2-CYCLE FULL-SYNTHETIC ENGINE OIL, 3.78L 28-1883-8...114,99
- 3. HUILE MÉLANGE SYNTHÉTIQUE POUR MOTEUR DE BATEAU XD50, 3,78 L / MARINE XD50 SYNTHETIC-BLEND ENGINE OIL, 3.78L 28-1886-2...91,99
- LUBRIFIANT POUR ENGRENAGES DE MOTEUR DE BATEAU QUICKSILVER, 1 L/QUICKSILVER MARINE GEAR LUBRICANT, 1L 28-1764-2...26,99
- HUILE POUR MOTEUR DE BATEAU, 500 ML OU 1 L/MARINE OIL, 500ML OR 1L 28-1882-0/1885-4...12,99-24,99

- 4. LIQUIDE DE TRANSMISSION AUTOMATIQUE ENTIÈREMENT SYNTHÉTIQUE DEX/MERC, 946 ML/DEX/MERC FULL-SYNTHETIC ATF, 946ML 28-1602-8...14,99
- 5. LIQUIDE DE TRANSMISSION AUTOMATIQUE ENTIÈREMENT SYNTHÉTIQUE MAXLIFE MULTI-VÉHICULES, 5 L/MAXLIFE MULTI-VEHICLE FULL-SYNTHETIC ATF, 5L 28-1598-8...54,99
- 6. LIQUIDE DE TRANSMISSION AUTOMATIQUE DEX/MERC, 5 L/DEX/MERC ATF, 5L 28-1601-0...53,99
- CERTAINS LIQUIDES DE TRANSMISSION AUTOMATIQUE VALVOLINE, 946 ML OU LUBRIFIANT DE JOINT TORIQUE PERMATEX, 28 GAL/SELECTED VALVOLINE ATF, 946ML OR PERMATEX O-RING LUBRICANT, 28G 28-1599X/38-1600-8...14,99-15,99



HUILE POUR MOTEUR DE BATEAU À 2 OU 4 TEMPS, 946 ML OU 5 L/MARINE 2 OR 4-CYCLE ENGINE OIL 946mL or 5L 28-1809X. 15,99-82,99



TRAITEMENTS POUR SYSTÈME D'ALIMENTATION DE MOTEUR DE BATEAU SEA FOAM, 473 ML / SEA FOAM MARINE FUEL SYSTEM TREATMENT, 473ML 38-7814-4...18,99



HUILE À ENGRENAGES POUR PETIT MOTEUR OU MOTEUR DE BATEAU, 946 ML OU 5 L/SMALL ENGINE AND MARINE GEAR OIL 946ML OR 5L 28-1700X...16,99-69,99



HUILE POUR MOTEUR HORS-BORD, 4,4 L/OUTBOARD ENGINE OIL, 4.4L 28-1892-6...49,99
HUILE POUR MOTEUR HORS-BORD, 500 ML/OUTBOARD ENGINE OIL, 500ML 28-1726-4...10,99



7. HUILE POUR MOTEUR HORS-BORD ET EN-BORD Certains types et formats./OUTBOARD AND INBOARD MARINE OIL Selected types and sizes. 28-1740X...21,99-76,99
8. HUILE ET LUBRIFIANT D'ENGRENAGES DE HAUTE PERFORMANCE POUR MOTEUR DE BATEAU Certains types et formats./MARINE ENGINE OIL AND HIGH-PERFORMANCE GEAR LUBE Selected types and sizes. 28-1766X. 26,99-99,99



9. HUILE POUR MOTEUR DE MOTOCYLETTE À 2 TEMPS, 946 ML / 2-STROKE MOTORCYCLE OIL, 946ML 28-1891-8...12,99
10. LIQUIDE DE DÉMARRAGE, 311 GAL Formulé pour les conditions inférieures à zéro./QUICK START, 311G Formulated for sub-zero conditions. 38-2100-2...9,99





RABAIS/SAVE 25 %
HUILE MOTEUR SYNTHÉTIQUE
PERFORMANCE PROLONGÉE
 3 grades. 4,73 L./EXTENDED
PERFORMANCE SYNTHETIC
MOTOR OIL 3 grades. 4.73L.
 28-9460X. Cour./Reg 55,99
SOLDE/SALE 41,99 ch./ea

RABAIS/SAVE 25 %
HUILE MOTEUR SYNTHÉTIQUE
 6 grades. 4,73 L./SYNTHETIC
MOTOR OIL 6 grades. 4.73L.
 28-9450X. Cour./Reg 52,99
SOLDE/SALE 37,99 ch./ea

RABAIS/SAVE 25 %
HUILE SYNTHÉTIQUE POUR
MOTEUR À KILOMÉTRAGE ÉLEVÉ
 3 grades. 4,73 L./SYNTHETIC HIGH
MILEAGE MOTOR OIL 3 grades.
 4.73L. 28-9464X. Cour./Reg 54,99
SOLDE/SALE 39,99 ch./ea

RABAIS/SAVE 25 %
HUILE MOTEUR SYNTHÉTIQUE
0W16, 4,73 L./SYNTHETIC 0W16
MOTOR OIL, 4.73L 28-9447-0.
 Cour./Reg 52,99
SOLDE/SALE 37,99 ch./ea

RABAIS/SAVE 25 % CERTAINES HUILES MOTEUR/SELECTED MOTOR OIL 28-8809X. Cour./Reg 56,99-59,99...**SOLDE/SALE 41,99-44,99**



1. RABAIS/SAVE 50 \$
CRIC DE TONDEUSE/VTT
 Capacité de 300 lb max./LAWN
MOWER/ATV JACK Up to 300-lb
 capacity. 09-1534-6. Cour./Reg 229,99
SOLDE/SALE 179,99

2. RABAIS/SAVE 50 \$
CRIC DE MOTOCYCLETTTE/VTT Capacité
 de 1500 lb max./MOTORCYCLE/ATV
JACK Up to 1500-lb capacity. 09-1015-2.
 Cour./Reg 224,99...**SOLDE/SALE 170,99**



Grease Monkey



RABAIS
SAVE 15 %
GANTS JETABLES 8 MM, 50/PAQ. G, TG ou
 TTG./8MIL DISPOSABLE GLOVES, 50-PACK L, XL
 or XXL. 38-1127X.
 Cour./Reg 28,99...**SOLDE/SALE 24,59** ch./ea
RABAIS/SAVE 20 % GANTS JETABLES 15 MM,
50/PAQ. G ou TG./15MIL DISPOSABLE GLOVES,
 50-PACK L or XL. 38-1129X.
 Cour./Reg 34,99...**SOLDE/SALE 27,99** ch./ea



RABAIS/SAVE 40 \$ CRIC POUR
 SPORTS MOTORISÉS MOTOMASTER,
 1500 LB/MOTOMASTER POWERSPORT
JACK, 1500 LBS 09-1543-4.
 Cour./Reg 199,99...**SOLDE/SALE 159,99**



RABAIS/SAVE 20 \$
 CRIC EN ACIER ET EN
 FONTE DE SERVICE
 INTENSIF HI-LIFT,
 2,3 TONNES, 48 PO/
 HI-LIFT 2.3-TON 48"
HEAVY-DUTY CAST AND
STEEL JACK 09-0280-4.
 Cour./Reg 199,99
SOLDE/SALE 179,99



RABAIS/SAVE 40 % COMPRESSEUR
 D'AIR/GONFLEUR DE PNEUS CERTIFIÉ,
 12 V/CERTIFIED 12V AIR COMPRESSOR/
TIRE INFLATOR 09-5006-0.
 Cour./Reg 42,99...**SOLDE/SALE 24,99**



RABAIS/SAVE 20 % RAMPES POUR ENTRETIEN
 DE BERLINE CERTIFIÉ, 9000 LB/CERTIFIED SEDAN
MAINTENANCE RAMPS, 9,000 LBS 09-1560-2.
 Cour./Reg 89,99...**SOLDE/SALE 69,99**



Prêt comme un pro

Prep like a pro

Préparez-vous à profiter de chaque instant à bord de votre caravane.

Get ready to soak up every second of trailer season.

dicor products
An AIRXCEL Brand



- 1. RUBAN SCELLANT DIESEL, 4 PO x 25 PI/DISEAL SEALING TAPE, 4" x 25' 140-8288-4... 69,99
- 2. MASTIC D'ÉTANCHÉITÉ, BLANC Autonivelant ou non./LAP SEALANT, WHITE Self-levelling and non-levelling. 140-8275X... 19,99 ch./ea.
- 3. REVÊTEMENT DE TOIT EN CAOUTCHOUC EPDM, BLANC 1 gallon./EPDM RUBBER ROOF COATING, WHITE 1 gallon. 140-8286-8... 149,99
- SCÉLLANT AU BUTYLE, 1/2 PO x 3/4 PO x 30 PI/BUTYL-SEAL, 1/2" x 3/4" x 30' 140-8278-8... 21,99

SEAFLO
Make Water Work For You

- RABAIS/SAVE 10 % POMPE À EAU À MEMBRANE POUR VR/ BATEAU, 12 V 3.0 gal/min, 55 lb/PO²./RV AND MARINE DIAPHRAGM WATER PUMP, 12V 3.0GPM, 55PSI. 140-7950-2... 119,99
- POMPE BROYEUR, 12 V 12 GAL/MIN/MACERATOR PUMP, 12V 12GPM 140-7952-8... 229,99



RHINO



- 4. RABAIS/SAVE 10 % NÉCESSAIRE D'ÉGOUT POUR VR RHINFLEX, 15 PI/RHINFLEX RV SEWER KIT, 15' 40-8312-4. Cour./Reg 79,99...**SOLDE/SALE 68,99**
 - 5. RÉSERVOIR D'EAUX USÉES PORTATIF RHINO POUR VR, 21 GALLONS/ RHINO RV PORTABLE WASTE-HOLDING TANK, 21-GALLON 40-9733-6... 299,99
 - 6. RABAIS/SAVE 10 % RINCEUR DE BAC À EAUX USÉES BLASTER PRO RHINO POUR VR, AVEC ROBINET À VANNE/RHINO BLASTER PRO RV WASTE-HOLDING TANK FLUSHER WITH GATE VALVE 40-9734-4. Cour./Reg 89,99...**SOLDE/SALE 79,99**
- RABAIS JUSQU'À/SAVE UP TO 15 % CERTAINS ACCESSOIRES ET CONSOMMABLES SANITAIRES POUR VR/SELECTED RV ACCESSORIES AND SANITATION CONSUMABLES 40-6024X. Cour./Reg 26,99-119,99...**SOLDE/SALE 22,94-99,99**

CAMCO

- RABAIS/SAVE 20 % FILTRE À EAU TASTEPURE POUR VR, 2/PAQ./TASTEPURE RV WATER FILTER, 2-PACK 40-8849-8. Cour./Reg 49,99...**SOLDE/SALE 39,99**



WALEX

- 7. RABAIS/SAVE 20 % TRAITEMENT POUR RÉSERVOIR DE RÉTENTION CITRA-PAK, 30/PAQ./ CITRA-PAK HOLDING TANK DROP-IN TREATMENT, 30-PACK 40-9798-2. Cour./Reg 34,99...**SOLDE/SALE 27,99**
- 8. TRAITEMENT POUR RÉSERVOIR DE RÉTENTION CITRA-FRESH, 32 OZ/CITRA-FRESH HOLDING TANK TREATMENT, 32OZ 140-8290-6... 16,99
- TRAITEMENT POUR RÉSERVOIR DE RÉTENTION BIO-FRESH, 32 OZ Bleu ou vert./BIO-FRESH HOLDING TANK TREATMENT, 32OZ Blue or green. 140-8291-4/8292-2... 18,99 ch./ea



SONAX
MADE IN GERMANY



CERTAINS ARTICLES DE NETTOYAGE DE L'AUTO/SELECTED CAR CLEANING PRODUCTS 39-0749X... 19,99-32,99

ALPENA

Un éclairage continu par tout temps.
Uninterrupted illumination in all weather conditions.

- LUMIÈRES DE FÊTE SOLAIRES À DEL À CÂBLE, 30 PI/CABLE SOLAR PARTY LED LIGHTS, 30' 40-9754-6... 26,99
- AMPOULE À DEL, 12 À 24 V/12-24V SOFT LED BULB 40-9749-0... 19,49



SnapPad



TRousse DE CONVERSION UNIVERSELLE POUR CRIC EN LOSANGE, 4/PAQ./ UNIVERSAL CONVERSION KIT FOR SCISSOR JACKS, 4-PACK 140-8236-8... 299,99



ROBLOCK

- RABAIS/SAVE 15 % BLOCS DE MISE À NIVEAU POUR VR AVEC SAC, 8 PCES/ RV LEVELLING BLOCKS WITH BAG, 8-PC 40-1838-6. Cour./Reg 39,99...**SOLDE/SALE 33,99**
- RABAIS/SAVE 10 % CERTAINS ACCESSOIRES DE VR/SELECTED RV ACCESSORIES 40-8274X. Cour./Reg 13,99-59,99...**SOLDE/SALE 11,99-53,99**

LYNX



CALE DE ROUE LIL CHOCK, 2/PAQ./ LIL CHOCK WHEEL CHOCK, 2-PACK 140-8293-0... 23,99



TRousse DE MISE À NIVEAU POUR VR, 10 PCES/ RV LEVELLING KIT, 10-PC 40-1887-8... 59,99



Energizer



1. RABAIS/SAVE 100 \$ BLOC D'ALIMENTATION PORTATIF ARC 300 PRO AVEC BATTERIE LFP, 288 WH/ARC 300 PRO PORTABLE POWER STATION WITH LFP BATTERY, 288WH 40-1837-8. Cour./Reg 399,99...SOLDE/SALE 299,99

2. BLOC D'ALIMENTATION PORTATIF ARC 600 PRO À RECHARGE RAPIDE/ ARC 600 PRO QUICK-CHARGE PORTABLE POWER STATION 40-9696-4...649,99

3. PRISE DE CHARGE EXTÉRIEURE POUR VR ET VE, 50 A/50A RV/EV OUTDOOR CHARGING OUTLET 40-1984-6...59,99

4. BOÎTE DE JONCTION À 7 VOIES POUR REMORQUE AVEC FICHE INTÉGRÉE DE 8 PI/ 7-WAY TRAILER JUNCTION BOX WITH 8' INLINE PLUG 40-1981-2...54,99

RABAIS JUSQU'À/SAVE UP TO 20 \$ CERTAINS ACCESSOIRES DE VR/SELECTED RV ACCESSORIES 40-1858X. Cour./Reg 29,99-199,99...SOLDE/SALE 26,99-179,99

PRISE DE CHARGE, VÉRIFICATEUR DE PRISE ET STATION D'ALIMENTATION PORTATIVE/ CHARGING OUTLET, RECEPTACLE TESTER AND PORTABLE POWER STATION 40-1983X...24,99-1149,99

Rubbermaid

Assurez la sécurité de vos outils et de votre équipement; résiste aux intempéries.
Help keep tools & equipment secure; weather resistant.



5. RABAIS/SAVE 20 % BAC ACTION PACKER, 30,3 L Verrouillable./ ACTION PACKER TOTE, 30.3L Lockable. 40-3050-6. Cour./Reg 69,99 SOLDE/SALE 55,99

6. RABAIS/SAVE 50 \$ BAC ACTION PACKER, 181 L Verrouillable./ ACTION PACKER TOTE, 181L Lockable. 40-3055-6. Cour./Reg 249,99 SOLDE/SALE 199,99

Scott's



RABAIS SAVE 25 % SERVIETTE D'ATELIER HUMIDE TOUT USAGE ORIGINAL, BLEU/ ORIGINAL ALL-PURPOSE BLUE WET SHOP TOWEL 39-1100-6. Cour./Reg 13,99...SOLDE/SALE 9,99

DURA FAUCET



CERTAINS ROBINETS D'ÉVIER, DE LAVABO ET DE DOUCHE POUR VR/ SELECTED RV KITCHEN, BATHROOM AND SHOWER FAUCETS 140-8244X...34,99-49,99

oxygenics
Pure Shower Genius



CERTAINES POMMES DE DOUCHE À MAIN/SELECTED HANDHELD SHOWER HEADS/ SELECTED RV SHOWER HEADS, BRUSHED NICKEL AND WHITE 40-9700X...49,99-59,99

SIMONIZ



CERTAINS ARTICLES DE NETTOYAGE DE VR/SELECTED RV CLEANING PRODUCTS 40-8321X...13,99-15,99



RABAIS/SAVE 20 % DÉTACHANT DE TRAÎNÉES NOIRES, 3,78 L/ BLACK STREAK REMOVER, 3.78L 40-8331-8. Cour./Reg 34,99...SOLDE/SALE 27,99

NETTOYANT POUR TOITURE ET AUVENT, 3,78 L/ ROOF AND AWNING CLEANER, 3.78L 40-1874-8. Cour./Reg 34,99...SOLDE/SALE 27,99

3-IN-ONE

CERTAINS ARTICLES DE NETTOYAGE 3 EN 1 POUR VR/ SELECTED 3-IN-ONE RV CLEANING PRODUCTS 40-9703X...14,99-19,99





**RABAIS
SAVE
200 \$**

**TESTÉ
TESTED**

Bon transport! Happy hauling

Le chargement est lourd?
Pas de souci, nous pouvons
vous aider à le transporter.

Heavy lifting? No worries,
we can help carry the load.



- 1. REMORQUE UTILITAIRE EN GALVALUMESM PLUS AVEC HAYON À RAMPE, 5 X 7 PI./5 X 7' GALVALUMESM PLUS UTILITY TRAILER WITH RAMP GATE 40-8093-4. Cour./Reg 2508,99...**SOLDE/SALE 2308,99***
- 2. REMORQUE DE BATEAU GALVANISÉE ROBUSTE, 14 PI./14' HEAVY-DUTY GALVANIZED BOAT TRAILER 40-8610-4. Cour./Reg 1708,99...**SOLDE/SALE 1508,99***



- 5. **RABAIS/SAVE 300 \$** REMORQUE UTILITAIRE, 83 PO X 14 PI AVEC RAMPES LATÉRALES POUR VTT Capacité de 1850 lb. Modèle noir ou galvanisé offert./83 X 14' UTILITY TRAILER WITH ATV SIDE RAMPS 1,850-lb capacity. Available in black or galvanized. 40-8637X. Cour./Reg 4508,99-4908,99...**SOLDE/SALE 4208,99-4608,99***
- 6. **RABAIS/SAVE 200 \$** REMORQUE UTILITAIRE, 60 PO X 10 PI. Capacité de 1850 lb. Modèle noir ou galvanisé offert./60 X 10' UTILITY TRAILER 1,850-lb capacity. Available in black or galvanized. 40-8047X. Cour./Reg 3208,99-3408,99...**SOLDE/SALE 3008,99-3208,99***



- 7. **RABAIS/SAVE 5 \$** VERROU DE COUPLEUR UNIVERSEL AVEC 2 CLÉS/ UNIVERSAL FIT COUPLER LOCK WITH 2 KEYS 140-7298-6. Cour./Reg 36,99...**SOLDE/SALE 29,99**
 - 8. **RABAIS/SAVE 5 \$** CRIC PIVOTANT À BOULONNER, 10 PO Capacité de 1000 lb./ BOLT-ON SWIVEL MOUNT, 10-IN 1,000-lb capacity. 40-9041-2. Cour./Reg 57,99...**SOLDE/SALE 49,29**
- RABAIS JUSQU'À/SAVE UP TO 15 \$**
CERTAINS ACCESSOIRES DE REMORQUAGE/
SELECTED TOWING ACCESSORIES 40-6579X.
Cour./Reg 27,99-104,49...**SOLDE/SALE 23,79-94,49***



- RABAIS/SAVE 20 %** BÂCHE TRÈS ROBUSTE TOUGH, 12 X 16 PI/TOUGH HEAVY-DUTY TARP, 12 X 16' 40-5186-2. Cour./Reg 69,99...**SOLDE/SALE 55,99**
- RABAIS/SAVE 25 %** BÂCHE TOUGH DE PREMIÈRE QUALITÉ, 12 X 20 PI/ TOUGH PREMIUM TARP, 12 X 20' 40-5187-0. Cour./Reg 79,99...**SOLDE/SALE 59,99**



- RABAIS JUSQU'À
SAVE UP TO 25 %**
CERTAINS ENSEMBLES
DE PNEUS ET JANTES DE
REMORQUE HI-RUN/SELECTED
HI-RUN TRAILER TIRE ASSEMBLIES
40-8525X. Cour./Reg 72,49-354,49
SOLDE/SALE 65,69-319,49*



- 3. **BARRE D'ATTELAGE DE REMORQUE RÉGLABLE AVEC BOULES 2 PO, 2 5/16 PO ET CROCHET DE DÉPANNAGE 14 000 lb. Réglable./ADJUSTABLE TRAILER HITCH WITH 2", 2 5/16" AND TOW HOOK 14,000-lb. Adjustable. 140-6339-6...391,93**
- 4. **CONTRÔLEUR DE FREIN DE REMORQUE ECHO MOBILE 7 voies. Bluetooth./ECHO MOBILE TRAILER BRAKE CONTROLLER 7-way with Bluetooth. 140-6652...399,99**



- ENS. DE FREINS ÉLECTRIQUES POUR REMORQUE, 10 PO X 2,25 PO** Essieux de 3 500 lb. Côtés droit et gauche offerts./ELECTRIC TRAILER BRAKE ASSEMBLIES, 10-IN X 2.25-IN 3,500-lb axles. Left side and right side available. 140-9317X...**89,99-99,99**



- RABAIS/SAVE 30 %** BÂCHE ROBUSTE, 8 X 10 PI/HEAVY-DUTY TARP, 8 X 10' 40-5021-4. Cour./Reg 29,99...**SOLDE/SALE 20,99**
- RABAIS JUSQU'À/SAVE UP TO 50 %**
CERTAINES BÂCHES/SELECTED TARPS
40-5022X. Cour./Reg 39,99-139,99
SOLDE/SALE 27,99-109,99





RABAIS/SAVE 70 \$ PORTE-MOTOCYCLETTTE EN ALUMINIUM, CAPACITÉ DE 400 LB Rampe comprise./ALUMINUM MOTORCYCLE CARRIER, 400-LB CAPACITY Includes ramp. 40-9612-4. Cour./Reg 219,99...SOLDE/SALE 149,99****



ACHAT SPÉCIAL/SPECIAL BUY RAMPE DE CHARGEMENT PLIANTE À BARREAUX EN ACIER, 84 PO, PAIRE/84" STEEL RUNG FOLDING LOADING RAMP, PAIR 499-2239-6...99,99****
Jusqu'à épuisement des stocks./While quantities last.

RABAIS/SAVE 40 \$ RAMPE DE CHARGEMENT EN ALUMINIUM REPLIABLE EN DEUX, 85 PO/85" BI-FOLD ALUMINUM LOADING RAMP 40-8681-4. Cour./Reg 159,99...SOLDE/SALE 119,99****



TRANSPORTEUR EN ALUMINIUM POUR ACCESSIBILITÉ DE L'ATTELAGE/ALUMINUM HITCH ACCESSIBILITY CARRIER 40-1595-2...369,99****



RABAIS/SAVE 90 \$ TREUIL À CÂBLE SYNTHÉTIQUE, À DISTANCE SANS FIL, 3500 LB/3500 LB SYNTHETIC WINCH, WIRELESS REMOTE 140-8001-6. Cour./Reg 349,99...SOLDE/SALE 259,99****



RABAIS/SAVE 50 \$ ATTELAGE EN ALUMINIUM RÉGLABLE, ABAISSEMENT DE 8 PO 2 po et 2 3/8 po./ADJUSTABLE ALUMINUM TOW HITCH, 8-IN DROP 2" and 2 3/8". 40-6940-0. Cour./Reg 349,99...SOLDE/SALE 299,99****

RABAIS JUSQU'À/SAVE UP TO 10 \$ CERTAINS VERROUS DE COUPLEUR ET DE ROUE/SELECT COUPLER AND WHEEL LOCKS 40-6975X. Cour./Reg. 49,99-119,99...SOLDE/SALE 44,99-111,99****



1



2



1. RABAIS/SAVE 100 \$ TREUIL À CÂBLE SYNTHÉTIQUE EVO 10-S POUR VR, 10 000 LB/VR EVO 10-S SYNTHETIC WINCH, 10,000-LB 140-0076-6. Cour./Reg 1399,99...SOLDE/SALE 1299,99****

2. RABAIS/SAVE 300 \$ TREUIL À CÂBLE SYNTHÉTIQUE EVO, 8 000 LB/EVO 8,000-LB SYNTHETIC WINCH 140-0075-8. Cour./Reg 1199,99...SOLDE/SALE 899,99****

RABAIS/SAVE 300 \$ TREUIL À CÂBLE SYNTHÉTIQUE EVO, 12 000 LB/EVO 12,000-LB SYNTHETIC WINCH 140-0076-6 Cour./Reg 1499,99...SOLDE/SALE 1199,99****



RABAIS/SAVE 100 \$ REMORQUE/CHARIOT UTILITAIRE À CAISSE EN POLY Capacité de 1100 lb max./POLY BED UTILITY TRAILER CART Up to 1100-lb capacity. 127-9365-8. Cour./Reg 608,99...SOLDE/SALE 508,99*****



RABAIS/SAVE 50 \$ PANIER D'ATTELAGE EN ALUMINIUM Capacité de 500 lb./ALUMINUM HITCHBASKET 500-lb capacity. 40-2237-0. Cour./Reg 249,99...SOLDE/SALE 199,99****

RABAIS/SAVE 30 \$ PANIER D'ATTELAGE EN ACIER Capacité de 500 lb./STEEL HITCH BASKET 500-lb capacity. 40-2235-4. Cour./Reg 129,99...SOLDE/SALE 99,99****



Prêt pour les sentiers

Get ready to ride



HUILE POUR MOTEUR DE MOTO À 4 TEMPS 10W40 7000 MOTUL 946 ML OU 4 L/ MOTUL 7000 4-CYCLE 10W40 MOTORCYCLE OIL, 946ML OR 4L 28-1898X... 21,99-84,99

RABAIS/SAVE 10 % CERTAINES HUILES MOTEUR ET À ENGRENAGES/SELECTED MOTOR AND GEAR OIL 28-8600X. Cour./Reg 16,99-74,99 **SOLDE/SALE 15,29-67,49**

Pensez à ces incontournables pour profiter pleinement de vos balades à moto.

Help make the most of your ride with motorcycle must-haves.



RABAIS/SAVE 5 \$ CASQUES SHORTY VCAN Certains modèles et tailles./VCAN SHORTY HELMETS Selected designs and sizes. 27-2276X. Cour./Reg 68,99-84,99 **SOLDE/SALE 61,99-75,99**



RAIDER®

RABAIS/SAVE 25 % LUNETTES À MONTURE NOIRE SURGE Mousse haute densité à 3 couches. Modèle à 2 lentilles transparentes./SURGE BLACK GOGGLES 3-layer high-density foam. Clear, dual-lens design. 27-2541-8. Cour./Reg 57,99 **SOLDE/SALE 41,99**



REDLINE

3. RABAIS/SAVE 25 % CASQUE DE MOTOCYCLETTTE RI, NOIR MAT TP À TTG./RI MOTORCYCLE HELMET, MATTE BLACK XS-2XL. 27-4959X. Cour./Reg 99,99...**SOLDE/SALE 74,49 ch./ea**

4. RABAIS/SAVE 25 % CASQUE DE MOTOCYCLETTTE DEMI-COQUE HI, NOIR MAT TP À TTG./HI HALF-SHELL MOTORCYCLE HELMET, MATTE BLACK XS-2XL. 27-4953X. Cour./Reg 89,99...**SOLDE/SALE 67,49 ch./ea**



RABAIS/SAVE 5 \$ HOUSSE DE MOTOCYCLETTTE EN TOILE, MOYEN/FABRIC MOTORCYCLE COVER, MEDIUM 27-2150-8. Cour./Reg 39,99...**SOLDE/SALE 33,99**



TESTÉ TESTED

HUILE MOTEUR 10W40 DE CHOIX POUR VTT/VUTT, 946 ML/10W40 PREMIUM ATV/UTV ENGINE OIL, 946ML 28-1830-4... 13,99

HUILE MOTEUR SYNTHÉTIQUE 10W50 POUR VTT/VUTT, 946 ML/10W50 SYNTHETIC ATV/UTV ENGINE OIL, 946ML 28-8745-6... 15,99



TESTÉ TESTED

CERTAINES HUILES POUR MOTEUR DE MOTOCYCLETTTE À 4 TEMPS/SELECTED 4-STROKE MOTORCYCLE OIL 28-1820X. 14,99-25,99



HUILE MOTEUR 10W40 PREMIUM PLUS POUR VTT/VUTT, 946 ML/10W40 PREMIUM PLUS ATV/UTV ENGINE OIL, 946ML 28-1887-0... 21,99



1. HUILE MOTEUR SYNTHÉTIQUE 5W40 POUR VTT/VUTT, 946 ML/5W40 SYNTHETIC ATV/UTV ENGINE OIL, 946ML 28-2626-6... 25,99

2. HUILE MOTEUR SYNTHÉTIQUE 5W50 POUR VTT/VUTT, 946 ML/5W50 SYNTHETIC ATV/UTV ENGINE OIL, 946ML 28-8727-0... 26,99



RABAIS/SAVE 10 % HUILE MOTEUR 10W40, 946 ML/10W40 MOTOR OIL, 946ML 28-1860-2. Cour./Reg 24,99...**SOLDE/SALE 22,49**



RABAIS SAVE 5 \$ HUILE SEMI-SYNTHÉTIQUE POUR MOTEUR À 2 TEMPS, 3,78 L/SEMI-SYNTHETIC 2-CYCLE ENGINE OIL, 3.78L 28-8729-6. Cour./Reg 62,99...**SOLDE/SALE 55,99**

HUILE POUR MOTEUR DE MOTOCYCLETTTE PERFORMANCE ÉLEVÉE, 946 ML Certains types et grades./HIGH-PERFORMANCE MOTORCYCLE ENGINE OIL, 946ML Selected types and grades. 28-1730X. Cour./Reg 15,99-21,99 **SOLDE/SALE 14,39-19,69**



RABAIS SAVE 20 % SUPPORT DE MOTO/MOTORCYCLE STAND 27-4930-0. Cour./Reg 64,99 **SOLDE/SALE 51,99**

RABAIS/SAVE 25 % SANGLE D'ARRIMAGE UNIVERSELLE POUR ROUE DE MOTOCYCLETTTE/UNIVERSAL MOTORCYCLE WHEEL TIE-DOWN STRAP 40-2987-4. Cour./Reg 23,99...**SOLDE/SALE 17,99**



RAIDER®



**RABAIS JUSQU'À
SAVE UP TO 20 \$** CASQUE
DE VTT/MOTOCROSS RX2 POUR
ADULTES Certaines couleurs et
tailles./RX2 ADULT DIRT BIKE/ATV
HELMET Selected colours and sizes.
127-9277X. Cour./Reg 134,99-149,99
SOLDE/SALE 124,99-129,99



RABAIS/SAVE 40 \$
CASQUE FREESTYLE MX POUR JEUNES
Certaines couleurs et styles./
YOUTH FREESTYLE MX HELMET
Selected colours and sizes. 127-9379X.
Cour./Reg 139,99...**SOLDE/SALE 99,99 ch./ea**



DEWALT



SANGLE DE REMORQUAGE DE CHOIX, 36 PO Force de rupture de 10 000 lb./
PREMIUM 36" AXLE STRAP Breaking strength of 10,000 lbs. 40-2979-4...**26,99**
SANGLE DE RÉCUPÉRATION, 75 000 LB, 6 PO X 30 PI/75,000-LB RECOVERY STRAP,
6" X 30' 40-2977-8...**219,99**
ENS. DE CORDE CINÉTIQUE, 1,25 PO X 30 PI X 52 600 LB./1.25" X 30' X 52,600 LBS.
KINETIC ROPE KIT 40-2995-4...**429,99**



MAXXIS®

**Y avez-vous pensé
You might need this**



**MANOMÈTRE POUR
PNEU DE VTT/VUTT SIGI/
SIGI ATV/UTV TIRE PRESSURE GAUGE**
127-9230-8...**19,99**



**1. RABAIS/SAVE 20 % PNEU DE VTT/VUTT
BIGHORN 2.0/BIGHORN 2.0 ATV/UTV TIRE**
27-8173X. Cour. à partir de/Reg from 232,49
SOLDE, À PARTIR DE/SALE, FROM 186,89*
PNEU DE VTT/VUTT ZILLA/ZILLA ATV/UTV TIRE
27-8150X. Cour. à partir de/Reg from 166,49
SOLDE, À PARTIR DE/SALE, FROM 134,09*
**2. PNEU DE VTT/VUTT CEROS/CEROS ATV/UTV
TIRE 27-4265X...À PARTIR DE/FROM 224,49***



**KOLPIN
OUTDOORS**

3

3. RABAIS/SAVE 5 \$ POIGNÉE RHINO À MONTAGE DÉCALÉ, TG/RHINO GRIP OFF-SET MOUNT, XL
127-9385-0. Cour./Reg 52,99...**SOLDE/SALE 47,99**
4. RABAIS/SAVE 5 \$ POIGNÉE À CLIQUET RHINO, 2/PAQ./RATCHETING RHINO GRIP, 2-PACK
27-1815-4. Cour./Reg 84,99...**SOLDE/SALE 75,99**
5. RABAIS/SAVE 10 \$ POIGNÉE DOUBLE XLR RHINO, 2/PAQ./XLR DOUBLE RHINO GRIP, 2-PACK
27-2596-8. Cour./Reg 104,99...**SOLDE/SALE 94,99**
6. POIGNÉE FLEX 1.5 RHINO, 2/PAQ./FLEX 1.5 RHINO GRIP, 2-PACK 27-2597-6. Cour./Reg 20,99...**SOLDE/SALE 16,99**

4

5

6

**MOTOMASTER
ELIMINATOR**

**TESTÉ
TESTED**

7

8

9

**7. BATTERIES AGM POUR SPORTS MOTORISÉS
ACTIVÉES EN USINE Prêtes à installer./
FACTORY-ACTIVATED AGM POWERSPORT
BATTERIES Ready to install.**
27-1560X...**À PARTIR DE/FROM 91,99****

**8. RABAIS/SAVE 20 % AIDE-DÉMARRAGE AU
LITHIUM XB15, 1500 A/XB15 1500A LITHIUM
JUMP STARTER** 11-2095-6. Cour./Reg 174,99
SOLDE/SALE 139,99

**9. RABAIS/SAVE 15 % CALE DE ROUE POUR
MOTOCYCLETTE/MOTORCYCLE WHEEL CHOCK**
27-8135-0. Cour./Reg 79,99...**SOLDE/SALE 64,99**



**TROUSSE DE RÉPARATION DE PNEUS DE
VTT/VUTT CREVÉS/ATV/UTV FLAT TIRE
REPAIR KIT** 27-2715-6...**67,99**

RABAIS/SAVE 15 \$
SUPPORT UNIVERSEL
POUR SCIE À CHAÎNE
PRESS II/UNIVERSAL
CHAIN SAW PRESS II BRACKET 27-9200-8.
Cour./Reg 134,99...**SOLDE/SALE 119,99**



Premiers choix Hot picks

Des rabais remarquables sur des articles de sport exclusifs et bien plus pour profiter de la saison. Save big on exclusive sporting gear and more to soak up the season.



RABAIS
SAVE
50%

ARBALÈTE KILLER INSTINCT HD405/
KILLER INSTINCT CROSSBOW
HD405 HUNTERS KIT 75-0618-4.

Cour./Reg 599,99...**SOLDE/SALE 299,99**

Vendus conformément aux réglementations municipales, provinciales et fédérales. Vendus seulement à des fins sportives. Ne sont pas vendus là où la loi l'interdit./ Sold in accordance with local, federal and provincial laws. Sold for sporting purposes only. Not sold where prohibited by law.



RABAIS
SAVE
50%

LEURRE FLOTTANT GÉANT ORIGINAL, ÉDITION VRAI NORD/GIANT ORIGINAL
FLOATING LURE TRUE NORTH EDITION 277-0765-2. Cour./Reg 149,99...**SOLDE/SALE 99,99**



RABAIS
SAVE
185\$

GRAND COFFRE DE TOIT CONVOY XT Capacité de 16 pi³./CONVOY XT LARGE ROOFTOP CARGO BOX 16 cu-ft capacity. 40-1590-2. Cour./Reg 919,99...**SOLDE/SALE 734,99**

RABAIS/SAVE 170 \$ COFFRE DE TOIT CONVOY XT ALPINE Capacité de 13 pi³./ALPINE CONVOY XT ROOFTOP CARGO BOX 13 cu-ft capacity. 40-1589-8. Cour./Reg 869,99...**SOLDE/SALE 695,99**



2 Pcs
2-pc

RABAIS
SAVE
50%

T-SHIRT ET CASQUETTE
Tailles M à TTT./T-SHIRT AND
HAT COMBO Sizes M-XXL.
277-0735X. Cour./Reg 39,99
SOLDE/SALE 19,99 ch./ea



RABAIS
SAVE
50%

PLANCHE À PAGAIE GONFLABLE E10, 9 PI 9 PO
Capacité de poids maximum de 242 lb./
E10 9'9" INFLATABLE STAND-UP PADDLE
BOARD Up to 242-lb weight capacity. 79-8331-8.
Cour./Reg 249,99...**SOLDE/SALE 199,99**



RABAIS
SAVE
80%

POSTE D'ALIMENTATION PORTATIF AU LITHIUM POWERBOX
SURGE 250 Recharge avec panneau solaire./POWERBOX SURGE
250 LITHIUM PORTABLE POWER STATION Solar rechargeable.
11-2092-2. Cour./Reg 419,99...**SOLDE/SALE 335,99**

CRÉDIT OFFERT
*Crédit disponible avec une carte de crédit Triangle®. D'autres conditions s'appliquent. L'offre peut être modifiée ou annulée sans préavis. Visitez le site triangle.com/financing pour obtenir de plus amples renseignements.
*L'Argent CT est calculé à partir du nombre entier de litres de carburant acheté (essence ou diesel) avec votre carte de crédit Triangle, arrondis au litre entier le plus près. Le taux est sujet à changement et peut varier selon l'emplacement. Les titulaires de la carte World Elite Mastercard Triangle obtiennent 7¢ par litre d'essence super. L'essence super n'est pas disponible dans tous les postes Essence. Petro-Canada est un partenaire du programme Récompenses Triangle. Visitez la page des partenaires sur triangle.com pour les détails et les exclusions. ** Mastercard, World Mastercard, World Elite et la conception de cercles sont des marques de commerce déposées de Mastercard International Incorporated. Chaque fois que vous utilisez votre carte Récompenses Triangle ou votre carte Petro-Points liées pour régler des achats admissibles chez Petro-Canada et dans les postes Essence-participants, vous obtenez une prime de vingt pour cent (20%) de Petro-Points en plus de ce que vous obtenez d'habitude. Les points en prime ne sont pas calculés sur un gain déjà amplifié par la prime d'un autre partenaire. Votre compte doit être enregistré avec Récompenses Triangle et Petro-Points pour lier vos comptes. Une fois liés, les membres peuvent utiliser leur carte Récompenses Triangle ou carte Petro-Points pour obtenir de l'Argent CT et des Petro-Points chez Petro-Canada et dans les postes Essence-participants. Exclut le poste Essence-suivant : 2, rue Gauthier Nord., Notre-Dame-des-Pairies QC. Le programme Petro-Points est la propriété de Sunco Energy Inc., qui assure l'exploitation. Les Petro-Points ne sont pas accordés sur les taxes sur les achats non pétroliers, le tabac, les produits de vapotage, les cartes-cadeaux et les billets de transport en commun. Vous obtenez des Petro-Points sur les achats admissibles lorsque vous utilisez votre carte Petro-Points ou que vous payez avec une carte de débit ou de crédit RBC® liée. Vous devez vous rendre en magasin pour accumuler des points à l'aide de l'application Petro-Canada ou de votre carte Petro-Points numérique. Modalités du programme Petro-Points disponibles sur petro-points.ca/conditions. Petro-Canada est une entreprise de Sunco Energy Inc., le logo Petro-Canada, Petro-Points et le logo Petro-Points sont des marques de commerce de Sunco Energy Inc., utilisées sous licence. *** L'Argent Canadian Tire, l'Argent CT, Triangle, Récompenses Triangle et le logo du triangle sont des marques déposées appartenant à Canadian Tire Corporation, limitée, et sont utilisées sous licence.
La disponibilité des articles, les prix, la sélection et les offres promotionnelles peuvent varier d'un magasin à l'autre. Les prix courants indiqués sont les prix courants suggérés de Canadian Tire et sont les prix auxquels les articles seront offerts par Canadian Tire à la date de cette circulaire. Certains articles peuvent faire l'objet de frais supplémentaires, dont des frais de gestion environnementale ou d'élimination, qui peuvent varier d'une province à l'autre. Nous nous réservons le droit de limiter les quantités, de corriger les erreurs relatives à la typographie, aux illustrations ou aux prix, et à moins d'indication contraire, d'offrir des bons de rabais différé ou de substituer des articles équivalents quand les articles annoncés ne sont pas disponibles ou quand il s'agit d'erreurs publicitaires.
*Des frais d'expédition s'appliquent. Les frais d'expédition et de livraison varient en fonction de l'emplacement, de la taille et du poids des articles. L'expédition est seulement offerte dans la province du magasin Canadian Tire ou l'article ou les articles ont été achetés (« le magasin »). Les articles lourds/volumineux ne seront livrés que dans un rayon de 100 km du magasin. Sous réserve de certaines conditions et restrictions. Visitez le site https://www.canadiantire.ca/fr/service-a-la-clientele/comande-en-ligne.html pour plus d'informations. Le programme Récompenses Triangle est la propriété de la Société Canadian Tire, qui en assure l'exploitation. Les cartes de crédit Triangle® sont émises par la Banque Canadian Tire. Les primes sont octroyées sous forme d'Argent électronique Canadian Tire (Argent CT®). Pour obtenir de l'Argent CT en prime, vous devez présenter une carte ou un porte-clés du programme Récompenses Triangle, ou utiliser une façon approuvée de payer sans carte ou régler vos achats avec une carte de crédit Triangle. Vous ne pouvez pas obtenir de l'Argent Canadian Tire en billets sur les offres de prime. Tout taux multiplicateur de prime est calculé selon le taux de base de cumul d'Argent CT (0,4%) et sera ajouté au montant d'Argent CT que le membre obtiendrait sans la prime. Par exemple : Sur un achat de 100 \$ (avant les taxes) avec un multiplicateur de prime de 20x, le membre obtiendrait 8 \$ en prime sous forme d'Argent CT (soit 20 x 0,4% x 100 \$). Certains articles vendus ne sont pas admissibles à l'octroi ou à l'échange des primes en Argent CT. Des conditions s'appliquent. Visitez le site triangle.com pour obtenir toutes les modalités du programme et des renseignements sur l'emplacement des partenaires de Canadian Tire. Le taux offert est exclusif de toute prime, offre promotionnelle ou transaction d'échange. Le taux de prime 30x, réservé aux clients de la carte Mastercard® Triangle®. World Mastercard® Triangle® ou World Elite® Mastercard® Triangle®, est composé du taux de 10x les primes sur les achats quotidiens plus une prime de 20x l'Argent CT. *Un achat minimum de 150 \$ est requis pour être admissible d'obtenir la prime de 20x l'Argent CT. Le montant minimum de 150 \$ de dépenses s'applique au montant avant les taxes sur la même offre et pour une seule transaction. Les 150 \$ doivent être dépensés sur des articles permettant d'obtenir de l'Argent CT. L'Argent CT est calculé à partir du montant des achats avant les taxes. La prime en Argent CT devrait être appliquée au compte Récompenses Triangle du membre dans les 5 semaines. Aucun bon de rabais différé.
*** Mastercard, World Mastercard, World Elite et la conception de cercles sont des marques de commerce déposées de Mastercard International Incorporated. ** Sauf indication contraire, toutes les marques de commerce sont la propriété de La Société Canadian Tire limitée et sont utilisées sous licence.

CREDIT OFFERED
*Credit available with a Triangle® credit card. Other conditions apply. Offer subject to change or cancellation without notice. Visit triangle.com/financing for full details.
*CT Money is collected on the number of whole litres of fuel (gasoline or diesel) purchased when you pay with your Triangle credit card, rounded down to the nearest whole litre. Rate subject to change and could vary by location. Triangle World Elite Mastercard holders collect 7¢ per litre back on premium fuel. Not all Gas-locations have premium fuel. Petro-Canada is a Partner in the Triangle Rewards program. Visit the Partners page at triangle.com for details and exclusions. Each time you use your linked Triangle Rewards card or Petro-Points card on qualifying purchases at Petro-Canada and participating Gas-locations, you will earn a bonus of twenty percent (20%) more Petro-Points than you normally earn. Bonus points are not calculated on an earn already amplified by another partner bonus. You must have a registered account with both Triangle Rewards and Petro-Points to link your accounts. Once linked, members can use either their Triangle Rewards or Petro-Points card to earn both CT Money® and Petro-Points at Petro-Canada and participating Gas-locations. Excludes the Gas-location at 2, rue Gauthier Nord., Notre-Dame-des-Pairies QC. The Petro-Points program is owned and operated by Sunco Energy Products Partnership. Petro-Points are not awarded on taxes on non-petroleum purchases, tobacco, vaping products, gift cards and transit tickets. Petro-Points are earned on qualifying purchases when you use your Petro-Points card or pay using a linked RBC® debit or credit card. You must go in-store to collect points using the Petro-Canada app or your digital Petro-Points card. Petro-Points program terms and conditions available at petro-points.ca/terms. Petro-Canada is a Sunco business. Petro-Canada, the Petro-Canada logo, Petro-Points and the Petro-Points logo are trademarks of Sunco Energy Inc. Used under licence. ** Canadian Tire Money, CT Money, Triangle, Triangle Rewards and the Triangle design are registered trademarks owned by Canadian Tire Corporation, Limited, and are used under licence.
Product availability, pricing, selection, and promotional offers may vary by store. Regular prices shown are Canadian Tire's suggested regular prices and are the prices at which the products will be offered by Canadian Tire as of the date of this flyer. Certain items may be subject to additional fees or charges, including environmental handling or disposal fees, which may vary by province. We reserve the right to limit quantities, to correct typographical, illustrative or pricing errors, and unless otherwise indicated, to offer rainchecks or substitute equivalent products where advertised products are unavailable or in the event of advertising errors. *Shipping fees apply. Shipping fees and delivery times vary depending on location, size and weight of the item(s). Shipping is only available within the province of the Canadian Tire retail location from which the item(s) was purchased ("Store"). Heavy/Oversized items will only be delivered within a 100km radius of the Store. Conditions and restrictions apply. Visit https://www.canadiantire.ca/en/deliver-to-home.html for more information. The Triangle Rewards Program is owned and operated by Canadian Tire Corporation, Limited. Triangle® credit cards are issued by Canadian Tire Bank. Rewards are in the form of electronic Canadian Tire Money® (CT Money®). To collect bonus CT Money you must present a Triangle Rewards card/key fob, or use any approved cardless method, at time of purchase or pay with a Triangle credit card. You cannot collect paper Canadian Tire Money on bonus offers. Any bonus multiplier is based on the base rate of collecting CT Money (0.4%), and will be added to whatever the Member would otherwise collect, without the bonus. Example: On a \$100 (pre-tax) purchase with a 20x bonus multiplier a Member would earn a bonus \$8 in CT Money (20 x 0.4% x \$100). Not all items sold are eligible to earn CT Money or to be redeemed for. Conditions apply. Visit triangle.com for full program rules and Partner location information. The offered rate is exclusive of any bonus or promotional offers or redemption transactions. * The 30x for Triangle® Mastercard®, World Mastercard® and World Elite Mastercard® customers consists of the 10x everyday plus a 20x bonus. Minimum purchase of \$50 or more required to receive the 20x bonus. Minimum \$50 spend is on the pre-tax amount on the same tender and for a single transaction. \$50 must be spent on items that earn CT Money. CT Money is collected on the pre-tax amount of the purchase. Bonus CT Money may take up to 5 weeks to be applied to the Member's Triangle Rewards Account. No rainchecks.
*** Mastercard, World Mastercard, World Elite and the circles are registered trademarks of Mastercard International Incorporated. ** Unless otherwise noted, all trademarks are owned by Canadian Tire Corporation, Limited and are used under licence.





Bon départ Jumpstart

Bon départ s'engage à éliminer les obstacles financiers et d'accessibilité au sport et au jeu pour les jeunes d'un océan à l'autre du pays.

Ensemble, nous pouvons favoriser leur réussite à long terme en leur permettant d'accéder à des sports abordables.

Pour en savoir plus,
visitez jumpstart.canadiantire.ca.

Jumpstart is committed to removing financial and accessibility barriers to sport and play for Canadian youth from coast-to-coast-to-coast.

Together, we can enable lifelong success through access to affordable sport.

To learn more, visit jumpstart.canadiantire.ca.

